

# Description and Operational Specifications

## Contents

<b>DOS-2</b>	<b>1.1 CE Certification</b>	<b>DOS-9</b>	<b>1.5 Operational Specifications &amp; Limitations</b>
DOS-2	1.1.1 Regulators CE Certification	DOS-10	1.5.1 Using a High-Pressure Breathing Gas Supply
DOS-2	1.1.1.1 SuperFlow 350 CE Certification	DOS-11	1.5.2 Use of QD fittings on the Main Supply
DOS-2	1.1.1.2 455 Balanced Regulator CE Certification	<b>DOS-11</b>	<b>1.6 Helmet Features</b>
DOS-2	1.1.1.3 Diamond Exhaust CE Certification	<b>DOS-14</b>	<b>1.7 General Description</b>
DOS-2	1.1.2 Helmet CE Certification	DOS-14	1.7.1 Fiberglass Helmet Shell
DOS-2	1.1.3 Band Mask® CE Certification	DOS-15	1.7.2 Stainless Steel Helmet Shell
DOS-2	1.1.4 CE Marking	DOS-15	1.7.3 Gas Flow Systems
DOS-3	1.1.4.1 CE Marking Helmet	DOS-17	1.7.4 Free Flow
DOS-3	1.1.4.2 CE Marking BandMask®	DOS-18	1.7.5 Emergency Gas Supply System (EGS)
DOS-3	1.1.4.3 Diamond Regulator CE Marking	DOS-18	1.7.6 Helmet Attachment to the Diver
DOS-6	1.1.4.4 Diamond Helmet CE Marking	DOS-20	1.7.7 Sealing Arrangement
DOS-6	1.1.4.5 CE Marking Surface Supplied MOD-1	DOS-21	1.7.8 Reducing Carbon Dioxide
DOS-7	1.1.5 Notified Body	DOS-21	1.7.9 Communications
DOS-7	1.1.6 Intended Use	DOS-21	1.7.10 Equalizing the Middle Ear
<b>DOS-8</b>	<b>1.2 Product Specifications</b>	DOS-21	1.7.11 Face Port or Viewing Lens
<b>DOS-9</b>	<b>1.3 Regulator Performance</b>	DOS-21	1.7.12 SuperLite® 17B Latch Catch Assembly, Pull Pin
DOS-9	1.3.1 SuperFlow® and SuperFlow® 350 Demand Regulators	<b>DOS-22</b>	<b>1.8 Accessories</b>
DOS-9	1.3.2 455 Balanced Regulator Performance	DOS-22	1.8.1 Eye Protection for Welding
DOS-9	1.3.3 KM Diamond Regulator Performance	DOS-23	1.8.2 Hot Water Shroud Kit and Water Shroud Kits
DOS-9	1.3.4 Minimum Operating Temperature Surface Supplied Air Diving	DOS-24	1.8.3 Special Regulator Tools for the SuperFlow® and the SuperFlow® 350
<b>DOS-9</b>	<b>1.4 Cage Code</b>	DOS-24	1.8.4 Special Regulator Tools for REX® Regulator

**DOS-25 1.9 Helmet Transport And Storage**

DOS-25 1.9.1 Transport

DOS-26 1.9.2 Storage

**DOS-26 1.10 Band Mask® Transport And Storage**

DOS-26 1.10.1 Transport

DOS-28 1.10.2 Storage

DOS-28 1.10.3 Helmet Carrying Bag

**DOS-28 1.11 Use of Kirby Morgan Original Replacement Parts**

**⚠ WARNING**

This manual is our effort to explain the operation, maintenance and use of the Kirby Morgan helmet. We do not herein make any effort to teach the principles of diving. It is our assumption the reader is a qualified diver. We highly recommend that all divers should train, under controlled conditions, in the use of any model of commercial diving helmet that they have not previously used or trained in, prior to use on the job, until they have mastered the skills required to use their helmet correctly. Kirby Morgan helmets are intended for professional use only and are not intended for recreational use by persons not trained in surface supplied procedures and practices.

This section includes detailed descriptions of Kirby Morgan helmets, as well as important operational specifications.

**1.1 CE Certification**

**1.1.1 Regulators CE Certification**

**1.1.1.1 SuperFlow 350 CE Certification**

SuperFlow® 350 regulator has been tested and conforms to the performance requirements as set forth in Annex II of Regulation (EU) 2016/425.

**1.1.1.2 455 Balanced Regulator CE Certification**

455 Balanced Regulator has been tested and conforms to the performance requirements as set forth in Annex II of Regulation (EU) 2016/425

**1.1.1.3 Diamond Exhaust CE Certification**

The Diamond Exhaust and demand regulators have been tested and conform to the performance requirements as set forth in Annex II of Regulation (EU) 2016/425.

**1.1.2 Helmet CE Certification**

The helmet has been tested and conforms to the performance requirements as set forth in Annex II of Regulation (EU) 2016/425 and, as far as applicable, the EN15333-1 (class B). It is fully CE marked with the Diamond Exhaust, demand reg-

ulators and oral nasals P/N 510-690, P/N 510-740 and P/N 510-747.

Category of PPE: III

**1.1.3 Band Mask® CE Certification**

The Band Mask® has been tested and conforms to the performance requirements as set forth in Annex II of Regulation (EU) 2016/425 and, as far as applicable, the EN 15333-1 (Class C). It is fully CE marked with demand regulator 455 balanced, SuperFlow® 350 and oral nasal masks P/N 510-690 and P/N 510-747.

Category of PPE: III

**⚠ WARNING**

The helmet or Band Mask® has been tested with air and CE certificated for use with air up to 50 meters. Compressed air must be compliant with the EN 12021.

All the tables reporting the technical data and the pressure of use are relative to compressed air.

**1.1.4 CE Marking**

On the inside of the helmet shell the CE mark is affixed.

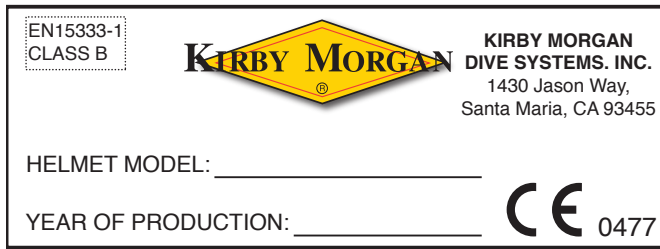

CE Mark on Helmets

**1.1.4.1 CE Marking Helmet**

In the mark on the helmets the following data is reported:

1. The name and the address of the manufacturer
2. Harmonized reference standard: EN 15333-1 plus Class B
3. PPE model
4. The year of production
5. CE marking: **CE**
6. Number of notified body

**1.1.4.2 CE Marking BandMask®**

On the frame of the Band Mask® the CE mark is affixed.

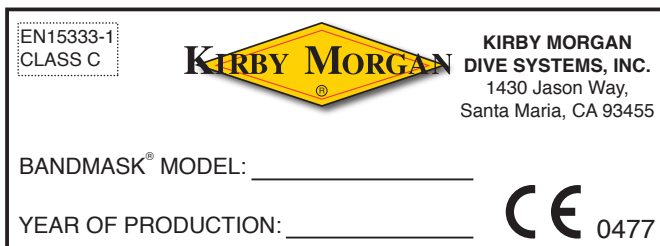

CE Mark on Band Masks®

In the mark on the Band Masks® the following data is reported:

1. The name and the address of the manufacturer
2. Harmonized reference standard: EN 15333-1
3. CLASS C = NO protection
4. Band Mask® model

5. Serial number (stamp on the BandMask® frame)
6. The year of production
7. CE marking: **CE**
8. Notifying Body number

**1.1.4.3 Diamond Regulator CE Marking**

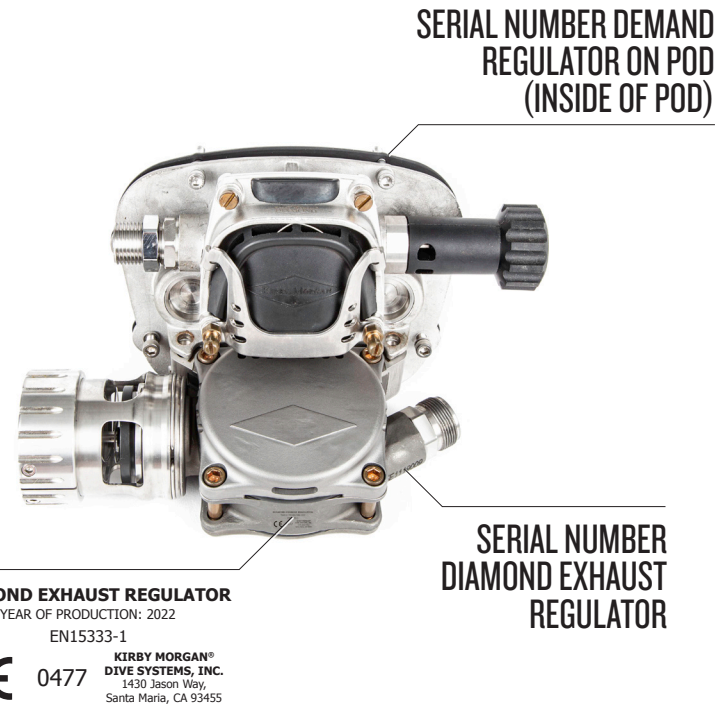

In the mark on the helmets the following data is reported:

1. The name and the address of the manufacturer
2. Harmonized reference standard: EN 15333-1
3. Demand Regulator serial number
4. Diamond Exhaust Regulator serial number
5. The year of production
6. CE marking: **CE**
7. Number of notified body



The above diagram depicts the location of the serial number on fiberglass helmets.

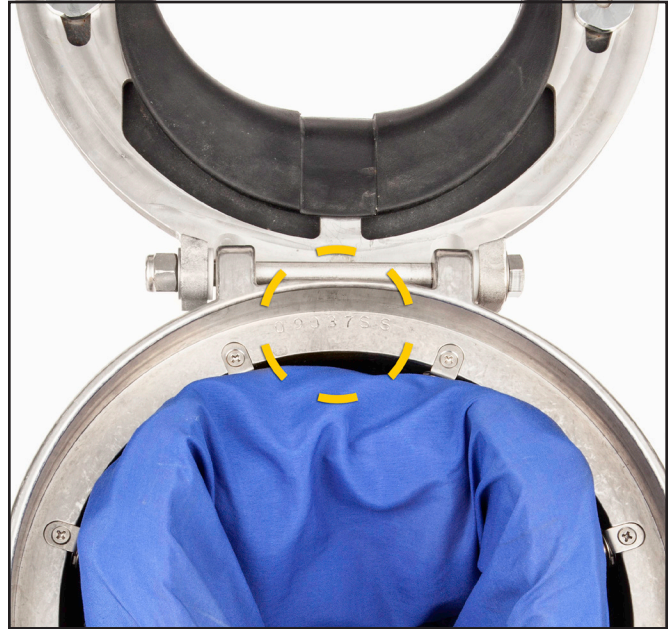

The above diagram depicts the location of the serial number on stainless steel helmets.

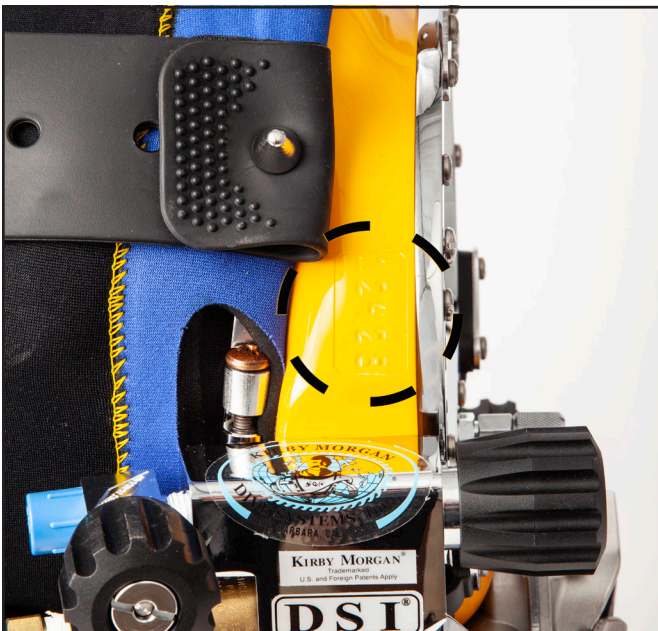

The above diagram depicts the location of the serial number on KMB 18 BandMasks.



The above diagram depicts the location of the serial number on KMB 28 BandMasks.

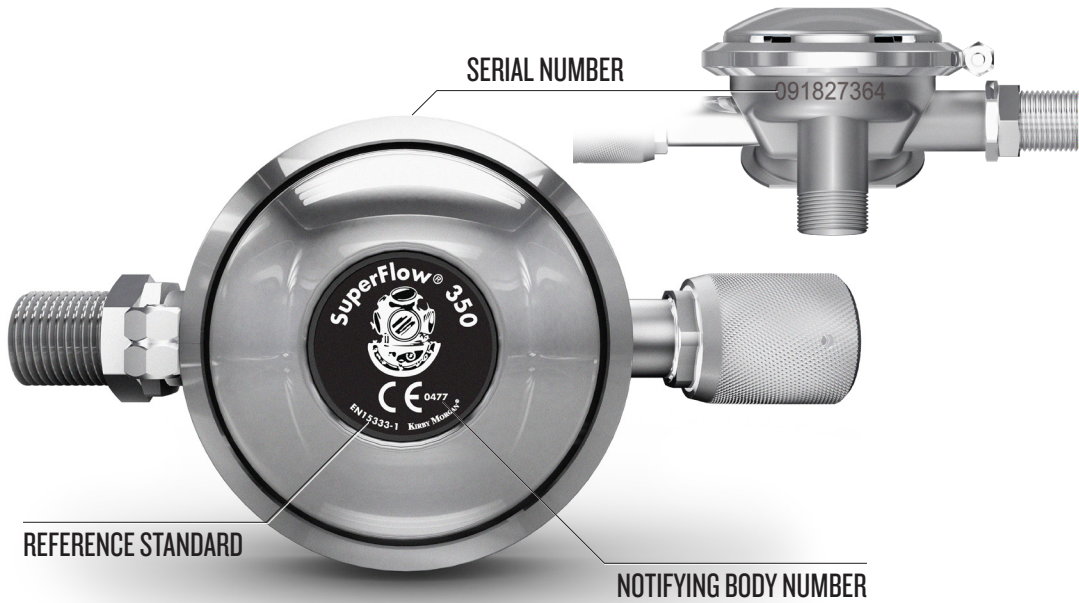

*The diagram to the left depicts the location of the notifying body number and reference standard on the exterior of the SuperFlow® 350 Regulator.*

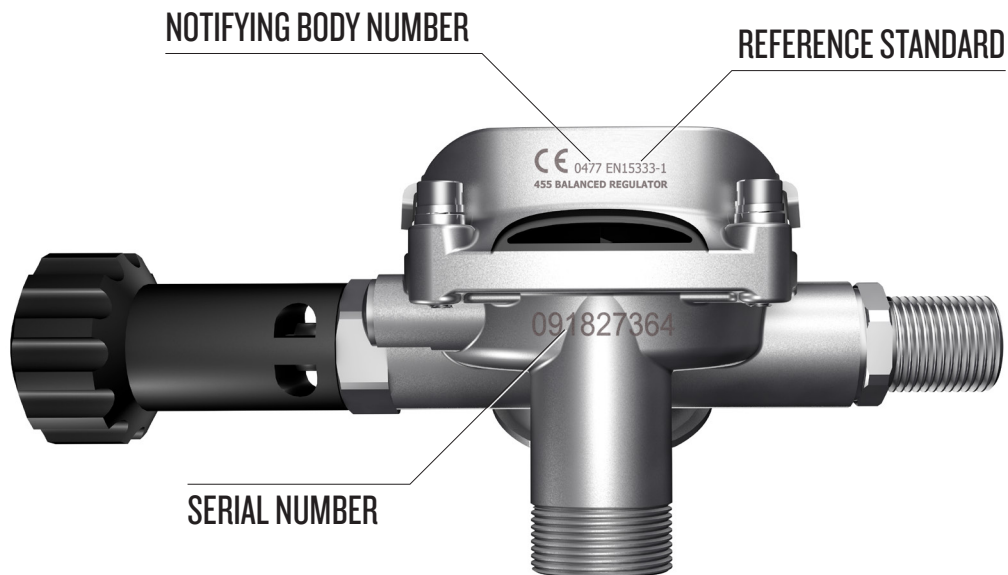

*The diagram to the left depicts the location of the notifying body number and reference standard on the exterior of the 455 Balanced Regulator.*

### 1.1.4.4 Diamond Helmet CE Marking

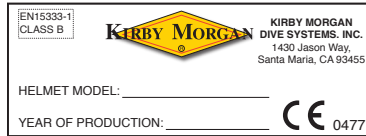

(INSIDE OF HELMET)



In the mark on the helmets the following data is reported:

1. The name and the address of the manufacturer
2. Harmonized reference standard: EN 15333-1
3. Demand Regulator serial number
4. Diamond Exhaust Regulator serial number
5. The year of production
6. CE marking: **CE**
7. Number of notified body

### NOTICE

The user cannot:

- Remove the mark from the shell of the helmet
- Modify or counterfeit the data reported on the mark.

### NOTICE

The mark must be visible and legible throughout the life of the PPE. If the mark deteriorates or is not legible the user should contact the manufacturer.

### 1.1.4.5 CE Marking Surface Supplied MOD-1

The Surface Supplied MOD-1 has been tested and conforms to the performance requirements as set forth in Annex II of Regulation (EU) 2016/425 and, as far as applicable, the EN 15333-1 (Class C). It is fully CE marked with Surface Supplied POD (P/N 805-225).

Category of PPE: III

On the underside of Pod Housing Sub assembly the CE mark is printed. On the Chamber Cover the data reported is the following:

1. The name and address of the manufacturer and year of manufacture
2. CE marking **CE**
3. The Model (Surface Supplied Pod)
4. Harmonized reference standard EN15333-1
5. Number of notified body



## KM DIAMOND OPERATING PARAMETERS

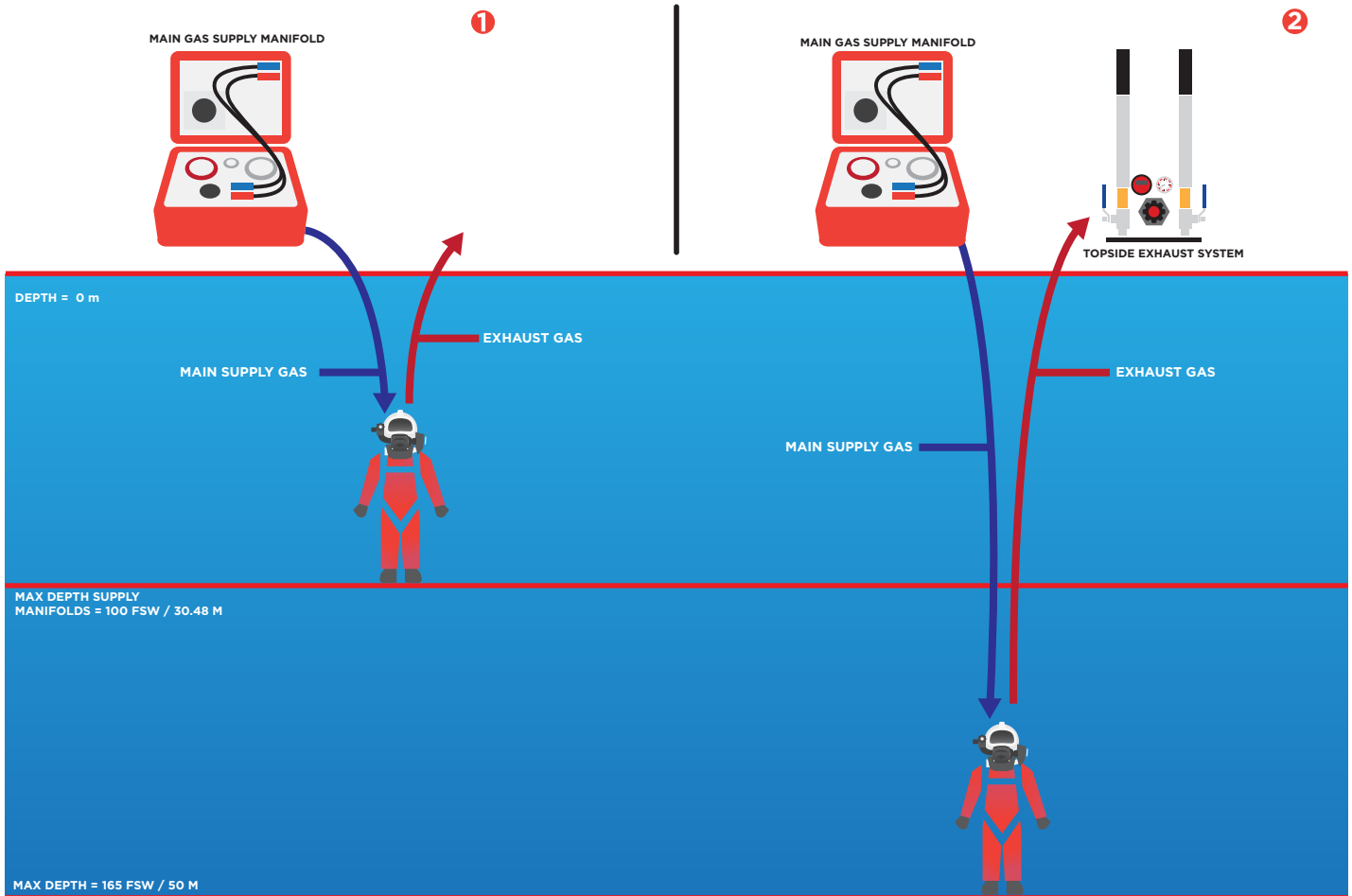

### 1.1.5 Notified Body

The Notified Body is:  
Eurofins Product Testing Italy Srl

Address: Via Courgné  
21-10156 Torino,  
ITALY

Identification number: 0477.

### 1.1.6 Intended Use

The Surface Supplied MOD-1 has been tested and conforms to the performance requirements as set forth in Annex II of Regulation (EU) 2016/425 and, as far as applicable, the EN 15333-1 (Class C).

It is fully CE marked with Surface Supplied POD (P/N 805-225) and the Surface Supplied MOD-1 P/N 500-800.

This mask is intended for diving to maximum depth of 165 fsw/50 msw and is not intended for the SCUBA diving configuration.

The Diamond Helmet is dive equipment for demand surface supplied that applies to the following:

<b>DEPTH</b>	0-165 FSW (0-50 M)
<b>GAS</b>	AIR
<b>MAX DEPTH WITHOUT TOPSIDE EXHAUST UNIT</b>	100 FSW (30.48 M <sup>1</sup> )
<b>MAX DEPTH WITH TOPSIDE EXHAUST UNIT</b>	165 FSW (50 M <sup>2</sup> )
<b>WATER TEMPERATURE</b>	34 °F-93.2 °F (1 °C-34 °C)
<b>WEIGHT OF PPE</b>	4.34 LBS 1.97 KG)
<b>WEIGHT OF DIAMOND EXHAUST REGULATOR</b>	2.05 LBS (0.93 KG)

<sup>1</sup> This number represents the CE limit for air diving and not the depth limit of the product.

<sup>2</sup> This number represents the CE limit for air diving and not the depth limit of the product.

<b>⚠ WARNING</b>	
	<p><b>When the helmet is used for air diving in countries that conform to C.E. regulations it must not be used deeper than a maximum depth of 165 fsw (50 msw). I.A.W. EN 15333-1.</b></p>

## 1.2 Product Specifications

### Weight:

SL 17B - 29.03 pounds  
 SL 17C - 30.6 pounds  
 SL 27 - 28.5 pounds  
 KM 37 - 32.6 pounds  
 KM 37SS - 30.96 pounds  
 KM 47 - 30.96 pounds  
 KM 77 - 32.43 pounds  
 KM 97 - 31.09 pounds  
 KM Diamond - 34.8 pounds

KMB 18 - 13.63 pounds  
 KMB 28 - 12.73 pounds

### For KM 37SS, 77, 97 and KM Diamond Helmets

Helmet Shell: Stainless steel

### For SL 17B, 17C, 27, 37, and 47 Helmets

Helmet Shell: Fiberglass, polyester resin, and carbon fibers

### For SL 17B, 17C, 27, 37, and 37SS

Regulator Body - Chrome Plated Brass

### For KM 47, 77, 97 and KM Diamond Helmets

Regulator Body - Stainless steel

### For BandMasks

Mask Frame KMB 18: Fiberglass, polyester resin, polyester gel coat, carbon fiber

Mask Frame KMB 28: Xenoy® thermoplastic

Control Knobs: ABS plastic

Lens: Clear polycarbonate

Hood: Neoprene.

O-rings: Buna-N

### For all helmets

Control Knobs: Polyurethane

Lens: Clear polycarbonate

Neck Dam: Neoprene. Optional latex neck dam available.

O-rings: Buna-N

Head Cushion: Nylon bag filled with #4 Polyester foam

Recommended Lubricants: Molykote® 111 Silicone Lubricant. Christo-Lube®, Krytox®, and Halocarbon® are also acceptable.



**⚠ WARNING**

**Never use aerosol-propelled sprays near the face port of any Kirby Morgan diving helmet. The propellant used in these aerosols can invisibly damage the face port and cause it to shatter on impact from any strong blow. If the face port fails underwater, injury or death may result.**

If you have any questions regarding proper set-up, operation, or maintenance of your Kirby Morgan helmet contact KMDSI (805) 928-7772 or at [kmddsi@KirbyMorgan.com](mailto:kmddsi@KirbyMorgan.com) or Dive Lab Inc. (850) 235-2715 or at [DiveLab@diveLab.com](mailto:DiveLab@diveLab.com). There are also detailed checklists for the set-up and maintenance of your helmet on the Dive Lab web site at [www.diveLab.com](http://www.diveLab.com), or the Kirby Morgan web-site under “Support” [www.kirbymorgan.com](http://www.kirbymorgan.com).

**1.3 Regulator Performance****1.3.1 SuperFlow® and SuperFlow® 350 Demand Regulators**

The SuperFlow® 350 non balanced regulator can be secured onto the SL 17C, SL 27, KM 37, KM 37SS and KMB 18/28 BandMasks.



Pre Sep. 2004 KMB 28 plastic frames will only accept the smaller mount tube found on the SuperFlow® (non 350) regulator.

The SuperFlow® 350 is fully CE marked.

**1.3.2 455 Balanced Regulator Performance**

The 455 Balanced Regulator is an all Stainless Steel regulator of a balanced design that offers far greater overall breathing performance than the non-balanced SuperFlow® and SuperFlow® 350 regulator. The 455 has virtually the same breathing performance as the REX® regulator, but is designed to be used with the SL 27®, 17C, KM 37 and KM 37SS helmets. The overall performance of this regulator is outstanding and sets a new performance standard for commercial diving helmets.

**1.3.3 KM Diamond Regulator Performance**

The inhalation regulator is based on the Balanced 455 demand regulator P/N 505-455. All individual parts inside the main tube assembly, but **NOT THE MAIN TUBE**, are interchangeable.

**1.3.4 Minimum Operating Temperature Surface Supplied Air Diving**

Kirby Morgan Helmets and BandMasks can be used in water at temperatures as low as 33 °F (0.6 °C) without the worry of demand regulator freezing without the use of a hot water shroud and hot water. However, it is strongly recommended that KMDSI water shrouds and hot water be used for the comfort of the diver whenever the water is colder than 34°F (1 °C), and /or anytime the top-side air temperature is below freezing to prevent the diver’s exhalation condensation from forming ice prior to entering the water.

**NOTE**

The greatest danger of demand regulator icing will be encountered on deck when the surrounding air temperature is less than 32 °F (0 °C).

**NOTE**

The use of the unit specific Water Shroud in conjunction with constant hot water to the diver should be used whenever surface supplied diving operations are conducted using HeO2 at water temperatures less than 60 °F (15.56 °C) for the comfort of the diver.

**1.4 Cage Code**

The cage code for identifying KMDSI products for U.S. government purposes is 58366.

**1.5 Operational Specifications & Limitations**

Every model of KMDSI helmet and mask undergoes extensive testing to fully document the performance capability and required supply pressures when using various umbilical and pressure combinations. All users should take the time to become knowledgeable on supply requirements to ensure proper performance and for the comfort and safety of the diver.

The required supply pressures for Kirby Morgan helmets are listed in the appropriate supply pres-

sure tables in “Supply Pressure Requirements & Tables” on page SUPR-1.

<b>⚠ WARNING</b>	
	<p><b>When the helmet is used for air diving in countries that conform to C.E. regulations it must not be used deeper than a maximum depth of 164fsw (50msw). I.A.W. EN 15333-1.</b></p>

The supply pressures listed in the supply tables were derived by breathing simulator trials. There are multiple tables for each regulator. It is important that users understand how to use the tables. For further information on supply requirements for the your Kirby Morgan helmet or mask check the Kirby Morgan website at [www.kirbymorgan.com](http://www.kirbymorgan.com).

-Umbilical minimum I.D.  $\frac{3}{8}$ " (9.5 mm) of not more than two sections, total length not to exceed 600 feet (183m).

The umbilical assembly should be composed of good quality diving hose that meets industry standards. Generally, gas hose will be married to the communications wire, pneumofathometer hose, and strength member in a manner that will allow the strength member to receive all the strain.

There are also good quality umbilicals available that are assembled at the factory using a twisted method which does not require marrying. Regardless of the system used, the umbilical is the diver's life line and should always be of excellent quality and maintained carefully.

If you have any questions regarding proper setup, operation, or maintenance of your Kirby Morgan helmet contact KMDSI (805) 928-7772 or at [kmddsi@KirbyMorgan.com](mailto:kmddsi@KirbyMorgan.com) or Dive Lab Inc. (850) 235-2715 or at [Divelab@DiveLab.com](mailto:Divelab@DiveLab.com).

## ⚠ DANGER

**Decompression diving always involves the risk of decompression sickness. Omitted decompression due to a loss of the breathing gas supply or other accidents can cause serious injury or death. Use of a Kirby Morgan helmet or mask cannot prevent this type of injury.**

### 1.5.1 Using a High-Pressure Breathing Gas Supply

High pressure (HP) control consoles are capable of supplying air or mixed gas at pressures and volumes much greater than low pressure air compressors, and are often preferred by military and scientific divers. HP air systems are often used as back up supply for LP compressor diving.

When using HP air or mixed gas systems, The regulator is normally loaded to 100–150 psig on the surface and increased to the bottom setting as the diver descends or when the diver reaches the bottom. During ascent the pressure is reduced to between 100–150 psig once the diver is shallower than 100 feet. A high-pressure gas supply is typically used under the following conditions:

- When the work load exceeds the capabilities of the compressor to supply a sufficient volume and pressure of breathing gas, regardless of the depth.
- When the diver is using pre-mixed gas.
- As a back-up for a low-pressure compressor
- Any time a high-pressure supply is available

The regulator is loaded as the diver increasingly descends and unloaded as the diver returns to the surface. If the diver experiences a free-flow with his regulator, when the bias adjustment knob is properly set and the regulator has been maintained correctly, the pressure setting on the high-pressure regulator may be set too high and may need to be decreased.

For recommended pressures when using a high-pressure breathing gas supply and a dome loaded regulator, see “Supply Pressure Requirements & Tables” on page SUPR-1. Generally speaking, the topside regulator should be set at 140 psig. over bottom pressure for optimum regulator performance.

**⚠ WARNING**

**The demand regulator and side block assemblies have a maximum design pressure of 300 psig (21 bar) over-bottom. Higher pressures could lead to component failure and serious personal injury.**

**⚠ WARNING**

**Gas systems used to supply Kirby Morgan helmets and masks must be capable of supplying gas to the diver at the required pressure and flow rates as stated in the operational specifications. The use of unregulated gas sources is extremely dangerous.**

**The use of standard SCUBA type regulators is unacceptable, as there are no provisions for adjusting the intermediate pressure to the diver. Only proven systems that allow for varying the gas supply pressure to the diver should be used for umbilical diving.**

### 1.5.2 Use of QD fittings on the Main Supply

Kirby Morgan strongly recommends that only umbilicals designed and manufactured specifically for Surface Supply Diving be used with KMDSI surface supplied helmets and full-face masks. The umbilical fittings used should be those recommended by the umbilical manufacturer.

Interface fittings attaching the umbilical to the side block one-way valve should be of good quality, made of brass or stainless steel or other non-corrosive material and rated for the required pressure. KMDSI recommends that the umbilical and interface fittings be visually inspected prior to each diving day for signs of stripped or damaged threads, signs of crimp slippage as well as any other signs of damage. Umbilical should be pressure tested at least once a year and / or whenever the integrity of the hose is in question for any reason.

KMDSI does not recommend using Quick Dis-

connect (QD) fittings as a connection of the main gas umbilical to the helmet side block. Attaching a quick connect fitting directly to the Helmet or BandMask® can pose a serious impact failure point due to the length of the QD attachment. Impact damage at the side block could result in the complete loss umbilical gas supply.

General industry practice, both commercial and military, often use an EGS whip assembly with QD fittings to attach the Emergency Gas Supply (EGS) Bailout System to the Helmet or BandMask®. KMDSI recommends that EGS QD whip assemblies be of a locking type, good quality, and made up internally and externally of non-corrosive materials such as brass or stainless steel. Any EGS whip and regulator assembly with or without a QD should be capable of flowing a minimum 35 scfm (1000 lpm) when measured at one atmosphere (on the surface) using a minimum dynamic steady intermediate supply pressure of at least 120 psig. Thirty-five (35) scfm (1000 lpm) at the surface, will allow the diver using a KMDSI helmet or BandMask® to breathe at minimum of 40 RMV to depths to 200 fsw (60 msw) on air, in the event main gas supply is interrupted or lost.

The first stage used for the EGS system should be of good quality and maintained IAW the manufacturer's recommendations. EGS interface whip assemblies should be pressure tested to 1.5 times of their rated working pressure at least once a year and/or whenever the integrity of the hose is in question for any reason.

The size of the EGS cylinder/cylinders should be determined by the hazards of the diving conditions and the amount of time necessary for the diver to surface, or get to a place where breathing gas can be restored. KMDSI surface supply Helmets and BandMasks® should never be used without a fully functional EGS system attached. The EGS cylinder valve should be open with the gas supply pressurized to the shut EGS valve on the side block. The EGS supply system should include an overpressure relief valve installed upstream of the side block EGS valve.

## 1.6 Helmet Features

All Kirby Morgan diving helmets are manufactured by hand. Each step of the manufacturing

process is carefully controlled to assure the customer receives a high quality, durable helmet that functions properly in all aspects.

All Kirby Morgan helmets, with the exception of the SL 17B, incorporate the innovative locking collar system. For the SL 17B helmet, the head cushion and the neck clamp/yoke assembly give the diver a secure fit in the helmet.

#### **SL 17B, 17C, 27, KM 37 and 37SS Helmets:**

These helmets accept the SuperFlow® 350 and the 455 Balanced regulators, providing ample breathing flow during peak work output.

#### **KM 47 and 77 Helmets:**

The 47 and 77 feature the REX® adjustable demand regulator which provides superior breathing gas flow during peak work output.

#### **KM 97 Helmet:**

The 455 Balanced Regulator on this helmet is a balanced design that offers far greater overall breathing performance than the non-balanced SuperFlow® and SuperFlow® 350 regulator. The overall performance of this regulator is outstanding and sets a new performance standard for commercial diving helmets.

Following the same design configuration of all our helmets the helmet consists of two main pieces; the helmet shell assembly and the neck dam/ring assembly. The machined helmet bottom ring houses the sealed pull pins and locking collar, and provides protection for the bottom end of the helmet shell. The adjustable neck pad on the locking collar, in combination with the internal chin strap and adjustable head cushion, gives the diver a secure, custom tailored fit in the helmet. The superior fit and balance makes the helmet sit comfortably for long periods of time even when working in the face down position.

A quick change communications module, available in either bare wire posts or a waterproof connector, allows for easy, efficient maintenance of the communications in the helmet.

#### **SL 17B, 17C, KM 37, 37SS and 97 Helmets:**

These helmets feature the Quad exhaust system which keeps the inside of the helmets dry and has low exhalation resistance. This exhaust sys-

tem helps to limit exposure during contaminated water diving.

#### **SL 27 Helmet:**

The Tri-Valve® exhaust system is standard equipment for the SL 27®. This superior exhaust system has exceptionally low exhalation resistance, and helps to keep the helmet free of contaminants in polluted water. The Tri-Valve® isolates the breathing system from the surrounding water with a three valve, low breathing resistance design.

#### **KM 47 and 77 Helmets:**

These helmets feature the REX® exhaust system. This exhaust system helps to limit exposure during contaminated water diving.

#### **KM Diamond Helmet:**

Features a two stage regulator that controls and routs the exhaled gas. Rapid removal and replacement is possible with clear access to all fasteners.

The bypass equalizer tube stabilizes the supply regulator, creates a protective bubble layer to the exposed valve and deflects exhaust bubbles from the diver's field of view when operating in open circuit mode.

The overpressure relief valve automatically activates if internal helmet pressure becomes too great. It can also be manually adjusted to improve breathing when operating in the open circuit mode or it can act as a standalone feature to dump exhaled gas directly into the surrounding water.

The surface bypass valve allows effortless switching from surface vent, (or reclaim), to standard open circuit diving mode. Switching back and forth from diving modes is instant with a single action.

<b>⚠ WARNING</b>	
	<p><b>Before attempting any diving in any type of contaminated water, a complete diving and top-side course in hazardous materials emergencies should be completed. The divers and the top-side team must be properly trained and have the proper safety equipment. All helmets and suits can leak water under certain conditions. Divers should use extreme caution when diving in contaminated waters.</b></p>

Helmet features which are common to all Kirby Morgan helmets include:

- The face port
- Communications components

Helmet features which are shared on certain Kirby Morgan helmets include:

- The oral/nasal mask is the same on: 17C, 17B, 37, 37SS and 97.
- The oral/nasal mask is the same on: KM 47 and 77.
- Unique oral/nasal mask: 27.
- Unique oral/nasal mask: KM Diamond.
- The bent tube is the same on: SL 17B, 17C, 27, KM 37, 37SS and 97
- The bent tube is the same on: KM 47 and 77
- Unique bent tube: KM Diamond
- Same nose block device on all except the 27.
- Same head and chin cushion in all except the 17B.
- Same Neck Ring/Neck Dam Assembly on all excluding the 17B: has a neck clamp/yoke.
- Units with shells in common: The 37SS, 77,

97 and KM Diamond. All others in current production have shells unique to their model.

The Kirby Morgan BandMask® KMB 18 and the Kirby Morgan BandMask® KMB 28 compare as follows:

- The face port (or view port) on the KMB 18 remains unchanged in shape from the Super-Lite® 17A/B. The face port in the KMB 28 is a slightly different size than the KMB 18.
- The water dump body is molded into the mask frame in the KMB 28.
- The exhaust covers on the two masks are slightly different.
- There is a vacuum formed comfort insert in the KMB 18.
- The air train in the KMB 28 requires a special standoff for proper mounting of the side block.
- The bent tube assembly that transports air/gas to the demand regulator from the side block is the same on both masks and on most Kirby Morgan helmets.

Many of the breathing system components on these helmets are also compatible with the KMB 18 and 28 BandMasks®. This helps reduce the inventory of spare parts that must be carried by commercial diving companies.

Each step of the manufacturing process is carefully controlled to assure the customer of a high quality, durable helmet that will function properly. The following is a general description of the features on the specified helmets.

#### **KM 37SS, 77, 97 and KM Diamond Helmets:**

The helmet is cast as a single piece and finished using computer controlled machinery. The bottom helmet ring receives the neck dam ring which seals to the helmet with an O-ring. The seal is very air/water tight. The metal bottom is quite durable in normal use, but care should be taken not to drag the helmet bottom on the deck.

The handle on top of the helmet can be used as a mounting bracket for lights, video cameras, etc. Removal of the handle is quick and easy and does

not require sealing to the helmet shell, as on the fiberglass models.

#### **SL 17C, 27, KM 37, and 47 Helmets:**

The handle on top of the helmet can be used as a mounting bracket for lights, video cameras, etc. The port weight on the 27, 37, and 47 may be used for this as well. The 17C features mounting brackets, one on each side of the handle.

#### **SL 17C, 27, KM 37, 37SS, 47, 77, 97 and KM Diamond Helmets:**

The neck dam is sandwiched between the neck dam rings, securely holding it in place. Replacement neck dams install easily. Latex or foam neoprene neck dams are available.

When the neck dam/neck ring is locked into place on the helmet, it is located up inside the protective helmet ring (that the neck ring O-ring seals to) which protects the neck ring and neck dam from side impact damage during the dive.

The neck dam design (latex or neoprene foam) helps position the helmet correctly. Replacement neck dams should only be genuine KMDSI/Kirby Morgan neck dams to assure proper operation and comfort. An internal adjustable chin strap helps to secure the diver's head in the helmet.

The locking collar design holds the neck ring in the sealed position. The O-ring seal is continuous once the neck ring is placed into the helmet ring.

Attached to the locking collar is an adjustable neck pad that should be adjusted to the diver prior to diving. This will improve the fit and performance of the helmet.

A system of two sealed pull pin locks is on the SL 17C, 27, 37, 37SS, 47, 77, 97 and KM Diamond. One lock is located on each side of the helmet. The spring and sliding shaft of these locks are inside an O-ring sealed main body. The interior of the main body is filled with silicone fluid. No fine sand or other debris can reach the interior of these locks to interfere with their operation.

The head cushion attaches just inside the bottom of the helmet, keeping it in place when the diver dons the hat. The standard head cushion consists of a reinforced nylon bag with an open cell foam inside.

#### **SL 17B Helmet:**

The neck dam on the SL 17B is secured by the neck clamp. Replacement neck dams install easily.

The head cushion attaches just inside the bottom of the helmet, keeping it in place when the diver dons the hat. The standard head cushion consists of a brushed nylon bag with an open cell polyester foam inside. Only genuine Kirby Morgan SL 17B head cushions should be used to ensure proper operation and comfort.

### **⚠ CAUTION**

**The 17B head cushion should not be used in other Kirby Morgan helmets because the design of the head cushion is different. Only genuine Kirby Morgan head cushions designed for the helmets should be used to assure proper operation and comfort.**

#### **SL 27, KM 37, 37SS, 47, 77 and 97 Helmets:**

The communications system is a modular, quick change design.

#### **SL 17C, KM 37, 37SS and 97 Helmets:**

The unique design of the Quad-Valve™ exhaust system helps keep exhalation resistance low while maintaining excellent watertight integrity.

#### **47 and 77 Helmets:**

The exhaust system is a three valve design, the REX®, that helps to keep the helmet exceptionally dry.

#### **KM Diamond Helmet:**

Features a two stage regulator that controls and routes the exhaled gas. Rapid removal and replacement is possible with clear access to all fasteners.

## **1.7 General Description**

### **1.7.1 Fiberglass Helmet Shell**

The helmet shell is fabricated of noncorrosive, rigid fiberglass which will not carry an electrical charge. This shell is the central structure for mounting all the components that make up the complete helmet. It is designed to allow easy replacement of parts when necessary. Any repair

to the helmet shell must be done at an approved KMDSI repair center.

The mask frame on the KMB 28 is made from Xenoy®, a thermoplastic that also will not carry an electrical charge.

### 1.7.2 Stainless Steel Helmet Shell

The helmet shell is fabricated of high grade corrosive resistant 316L stainless steel as a one piece unit. Along with the all steel material, what also sets this shell apart from fiberglass is that the large “bottom ring” is not a separate piece, but is an integral part of the overall shell. The stainless steel shells also do not require separate weights mounted to them, and the threaded inserts that accept the port retainer screws, have also been done away with as a separate part needing special maintenance and eventual replacement. This shell is the central structure for mounting all the components that make up the complete helmet. It is designed to allow easy replacement of parts when necessary. Any repair to the helmet shell must be done at an approved KMDSI repair center.

### 1.7.3 Gas Flow Systems

There are two breathing gas inlets on the side block. The main gas supply from the umbilical enters the system at the one way valve and flows through the valve to the interior of the side block. The one way valve or “non-return” is a very important component.

The one way valve prevents the flow of gas out of the helmet to the umbilical in the event of a sudden lowering of pressure in the umbilical. This can happen due to an accidental break in the hose or fitting near the surface. Not only would the emergency gas be lost if the one way valve failed (concurrent with a hose or fitting break on deck), but the diver could suffer from a serious “squeeze” that could cause injury or death.

## ⚠ DANGER

**Never connect the umbilical main gas supply hose from the diving station to the helmet emergency valve. There is no one way valve in the emergency gas valve. If this mistake is made, any break in the supply hose could possibly result in a “squeeze”. This could result in serious injury or death.**

Although we have selected the one way valve for its reliability and quality, inspection and maintenance of this valve must be done regularly and at a minimum at the beginning of each diving day. It is very easy to disassemble and inspect. (A rebuild kit for this valve is available, order P/N 525-330).

## ⚠ WARNING

**The one way valve must be tested daily, prior to the commencement of diving operations. Failure of one way valve could cause serious injury or death. Follow the procedures for testing the valve in this manual.**

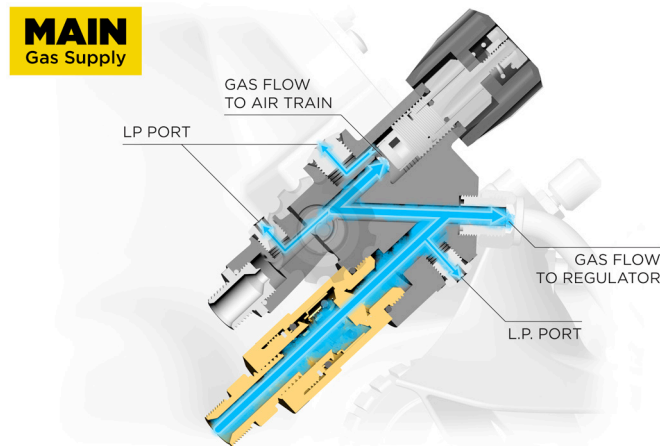

The secondary gas supply is the emergency gas and comes from a tank of compressed gas worn by the diver. It enters the system through the Emergency Gas Valve (EGS) when the diver opens the control knob. The gas then enters the side block.

Both sources of gas flow through the same passage in the side block body to three separate exits on the chromed or brass side block and four separate exits on the stainless steel side block. One exit is always open to supply gas to the de-

mand regulator. The second exit is to the defogger valve (also known as the free-flow or steady-flow valve) assembly. The third is to the port on the bottom of the side block.

On the underside of both side blocks a hole is drilled and tapped to accept a low-pressure inflator hose. This allows the diver the capability to inflate a dry suit or buoyancy compensator. It is tapped with a 3/8-24 thread orifice, standard for American first stage scuba regulator low-pressure auxiliary fittings.

As an added precaution, Kirby Morgan P/N 555-210 Restrictor Adapter should be used to limit gas flow in the event of an inflator hose parting or rupture. The restrictor adapter ensures the loss of gas supply would not be great enough to significantly affect the diver's breathing at moderate to heavy work rates. It would also help prevent filling the dry suit too rapidly.

The port is shipped plugged at delivery. This inflation capability does not significantly interfere in any way with the breathing characteristics of the regulator during normal use providing a limiting hose is used. The low-pressure inflation hose should be one that is restricted to flow less than 100 LPM.

is only supplied with gas when the EGS control knob is in the open position.

**Both of these ports are not** for dry suit or buoyancy compensator inflation. **ONLY** the port found on the underside of the side block should be used for dry suit or buoyancy compensator inflation.



*Low pressure hoses may be connected to the side block.*

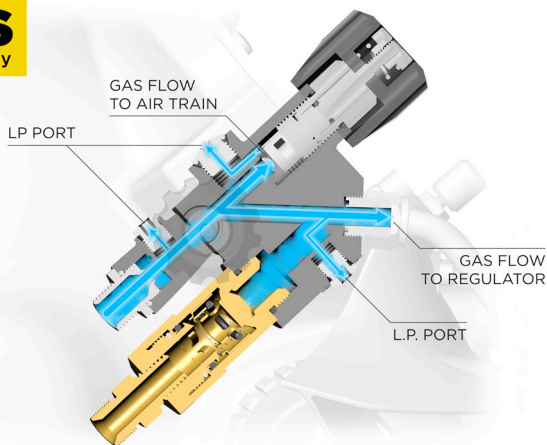

**On the stainless steel side blocks ONLY**, two additional ports are located on the top of the side block. The port farthest forward on the side block is controlled by the defogger control knob and only supplies gas to the port when the defogger knob is in the open position. The port farthest back is controlled by the EGS control knob and

### **⚠ WARNING**

The side block inflator port is intended for dry suits and buoyancy compensators only - NOT air tools. When using the side block low-pressure inflator port, only good quality hoses and fittings should be used and must incorporate an in-line flow restrictor to reduce gas flow in the event of hose failure. Any hose or fitting failure in this arrangement will subject the diver to a decreased air supply.

### **⚠ WARNING**

When using the side block low pressure inflator port, the diver should only use high quality hoses with an integrated flow restrictor.

The gas enters the helmet and flows through the air train which directs the gas onto the face port to help eliminate or clear fogging that forms on



the port from the diver's warm breath. In the event water gets inside, the helmet needs to be purged. Some of the air from the air train will force this water out through the main exhaust/water dump valve found just below the oral nasal mask, or to the port side, as in the SL 27® helmet.

The gas flow continues into the oral nasal mask by means of the oral/nasal valve. The diver can breathe from this flow of gas if the demand regulator malfunctions. The gas then flows into the regulator and out through the regulator exhaust. From there it can exit through either of the exhaust valves and out through the whiskers.

Returning to the side block assembly: the other passage for gas is to the demand regulator. It goes to a bent tube assembly that connects to the inlet nipple of the demand regulator. The flow of gas in the demand regulator assembly is controlled by the inlet valve that supplies gas to the diver on inhalation "demand" only, and shuts off during the exhalation cycle.

### **⚠ WARNING**

**The bent tube assembly for the KM 47 and 77 is a unique design and is not interchangeable with other bent tubes. Modifying to interchange could cause serious injury or death.**

The demand regulator senses the start of the diver's inhalation and opens the inlet valve, matching the diver's need. The regulator continues to match the diver's inhalation as the rate increases, peaks, then ebbs and stops. When the diver exhales, the supply gas stays off as the exhaled gas flows through the regulator body, out the regulator exhaust valve, through the whisker, and out into the water. The whisker wings deflect the exhaust bubbles away from the face port to keep the diver's view clear.

All KMDSI Helmets and Band Masks are equipped with a multi-turn demand regulator adjustment knob. This adjustment knob allows the diver to make corrections to compensate for a wide range of incoming gas supply pressures.

The adjustment knob operates by simply increasing or decreasing the amount of spring bias ten-

sion on the demand regulator inlet valve. The intent of this bias adjustment device is strictly to allow the diver to make adjustments for variations in umbilical supply pressure.

This adjustment device is not intended as a minimum-maximum device. Minimum and maximum applies to supply pressure only. The adjustment knob should be adjusted by the diver to be at the easiest breathing setting at all times. The exact number of turns required is dependent on the supply pressure.

### **⚠ CAUTION**

**Diving a KMDSI helmet or band mask with a bias setting greater than the smallest amount necessary to keep the demand valve from free flowing increases the work of breathing and reduces the diver's ability to perform heavy work.**

### **⚠ CAUTION**

**The regulator adjustment knob should be adjusted to the easiest breathing setting at all times. Adjusting the regulator further in than necessary to keep from free-flowing increases breathing resistance.**

## **1.7.4 Free Flow**

All KMDSI helmets and band masks can be used in a free flow mode through the use of the defogger valve (also known as the free flow or steady flow valve), or by the use of the demand regulator bias setting. Sometimes both are used together.

Using the helmet in the free flow dive mode increases noise levels and uses much more gas than when using in normal demand mode. However, it is recommended that the diver set up a very slight free flow when at rest and during decompression. A very slight free flow will keep CO<sub>2</sub> levels very low. Typically, with all dive helmets, CO<sub>2</sub> can build up inside the helmet during periods of inactivity due to the ratio of CO<sub>2</sub> produced compared to the amount of gas being breathed by the diver. By adjusting the helmet to a very slight free flow, just enough flow so it does not affect communications or become an annoyance,

this will keep CO<sub>2</sub> levels very low when the diver is inactive and at rest.

Running a continuous HEAVY FREE FLOW IS NOT RECOMMENDED because it makes communications difficult and subjects the diver to high levels of noise.

### 1.7.5 Emergency Gas Supply System (EGS)

KMDSI strongly recommends that the working diver carry an independent supply of compressed gas (or air) fitted with a first stage regulator and hose that is connected to the inlet of the Emergency Gas Supply Valve (EGS).

The KMDSI Overpressure Relief Valve, (part number 200-017) is fully adjustable and serviceable and has been designed to relieve any over-pressurization of the first stage regulator greater than the desired setting.

Every bailout (Emergency Gas System or EGS) first stage regulator must be fitted with an over-pressure relief valve to prevent over pressurization of the EGS L.P hose in the event the first stage develops a “creep” (i.e., leaks pressure).

#### ⚠ WARNING

**Be sure the Emergency air/gas first stage regulator is fitted with a relief valve for over-pressurization of the emergency gas supply hose. A leaky first stage can overpressure the hose resulting in hose rupture. This would cause a loss of the entire emergency gas supply, with possible serious injury or death.**



*The over-pressure relief valve should be installed on every first stage used for bailout.*

*KMDSI Part #200-017*



This valve can be adjusted for various relief pressures.

**NOTE**

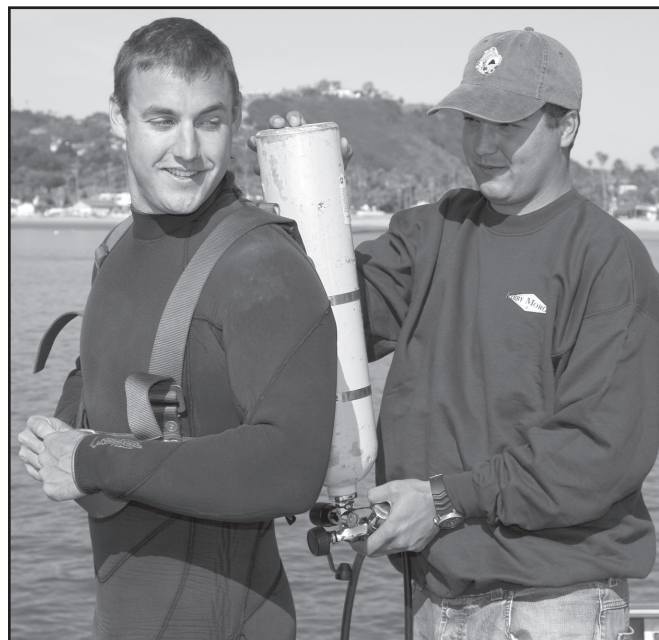

*The diver should always be equipped with an emergency gas system.*

#### ⚠ CAUTION

**Your emergency air/gas supply on a deep mixed-gas dive is extremely limited. All divers must be aware of exactly how long their bailout bottle will last at depth. For example, a diver breathing one cubic foot of air a minute at the surface will use up a 50 cubic foot bailout bottle in approximately 7 minutes at 198 FSW while at rest.**

### 1.7.6 Helmet Attachment to the Diver

SL 17C, 27, KM 37, 37SS, 47, 77, 97 and KM Diamond Helmets:

The ring on the base of the helmet shell has a machined O-ring sealing surface. The O-ring that seals against this surface sits inside the neck dam ring assembly. The neck dam ring is actually a multi piece assembly, consisting of the upper split rings and the lower stepped ring. The neck dam is captured (sandwiched) between these parts.

The locking collar and neck pad assembly has an opening smaller than most divers' heads, so the helmet is almost impossible to accidentally dislodge. The neck pad pushes against the neck dam and lower portion of the head cushion firmly securing the helmet to the diver's head. The neck pad also helps prevent neck dam balloon-

ing. Each diver must personally adjust the fit of their helmet by adjusting the neck pad, the head cushion, and the head cushion spacer. All of these parts together help provide a good fit.

Both sides of the helmet locking collar have a latch catch block to receive the locking sealed pull pins. If the sealed pull pins are turned to the locking position while the locking collar is open, the locking collar will snap into the locked position when it is pushed up into the helmet neck ring. The sealed pull pin on each side must be pulled to release the locking collar to remove the helmet. This system provides an extremely secure method of attaching the helmet to the diver.

The special locking sealed pull pins mentioned above are filled with silicone fluid. This helps to prevent fine sand or mud from entering the mechanism so as to avoid jamming.

The head cushion is made from layers of open cell foam inserted into a head shaped nylon bag. Adding or subtracting foam layers from the bag can adjust the fit of the head cushion. Extra cushioning and better fit may also be obtained by the use of the head cushion foam spacer. The head cushion must be adjusted correctly for the helmet to fit properly.

The relationship between the locking collar assembly, head cushion, head cushion foam spacer, chin cushion, and helmet shell all affect the fit of the helmet.

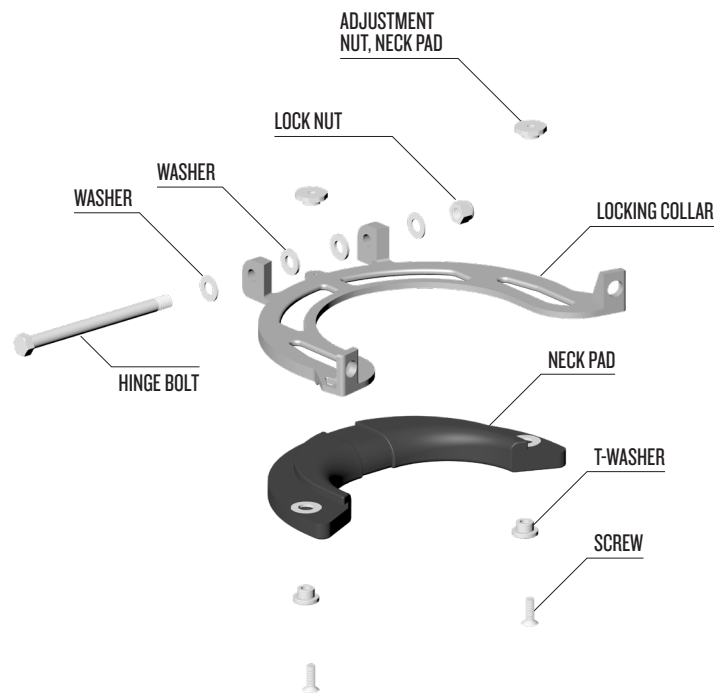

*The Locking Collar assembly.*

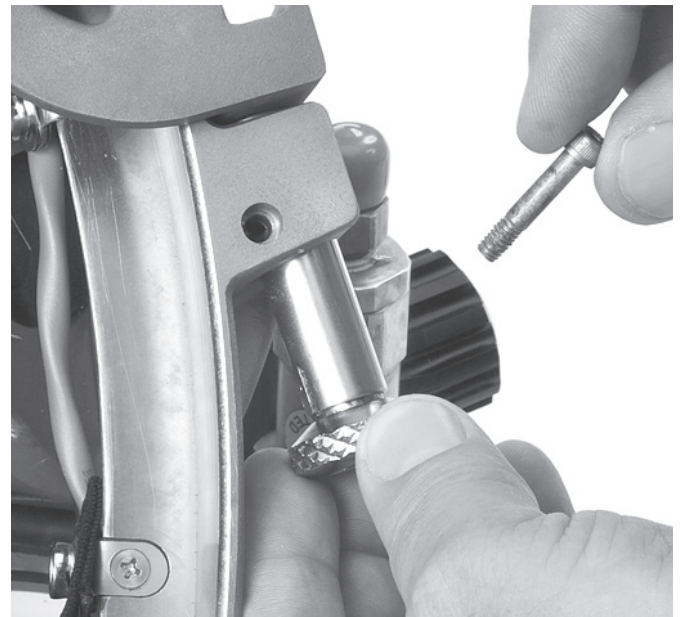

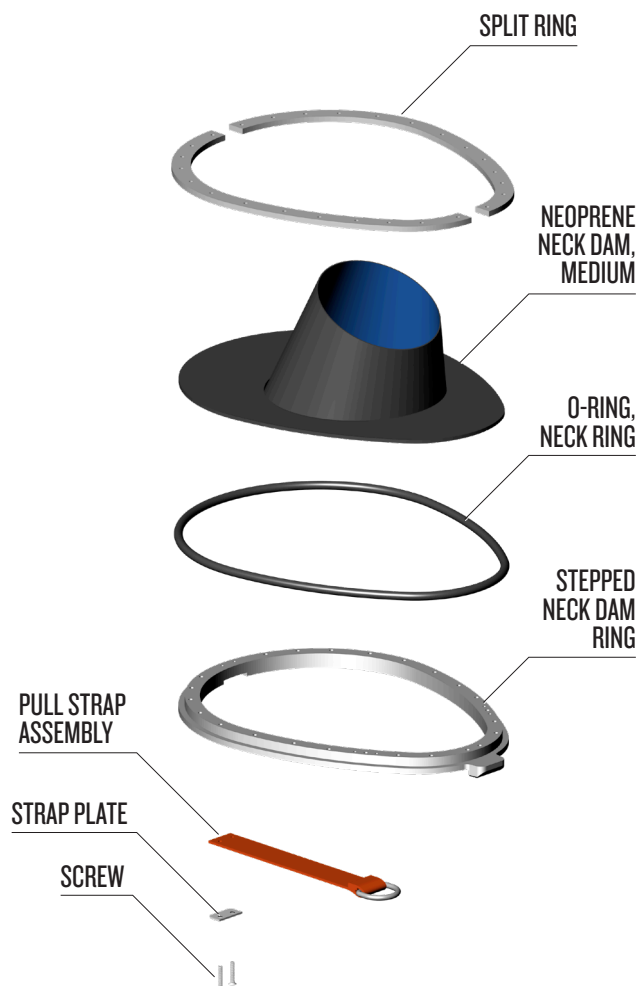

*The Neck Dam / Ring Assembly*

**SL 17B Helmet**

On the SuperLite® 17B, the helmet shell has an O-ring seal around the base of the fiberglass rim. The helmet is held in place on the diver’s head by the neck clamp/yoke assembly, which mounts on the diver’s neck and seals to the bottom rim of the helmet.

The adjustment of this clamp is critical to the safe use of the helmet. Periodic adjustments to the clamp **MUST** be made as the neck dam ages or if you convert to a dry suit mount. The adjustment should always be checked if the neck clamp/yoke assembly is used on different helmets. **YOU SHOULD NEVER HAVE TO FORCE THE CLAMP SHUT.**

**⚠ WARNING**

Be sure the Emergency air/gas first stage regulator is fitted with a relief valve in case of over-pressurization of the emergency gas supply hose. A leaky first stage can overpressure the hose resulting in hose rupture. This would cause a loss of the entire emergency gas supply, with possible serious injury or death.

**⚠ CAUTION**

The fit of the Kirby Morgan helmets is partially determined by the adjustment of the neck pad. If the neck pad is not properly adjusted it may be very uncomfortable on the diver’s neck. Take the time to adjust the neck pad properly and check the fit prior to each dive to ensure the adjustment has not changed.

**1.7.7 Sealing Arrangement**

The neck dam is available in several sizes and is fabricated in a cone shape. The standard neck dam on Kirby Morgan helmets is made of foam neoprene. Optional latex neck dams are available.

The neck dam seals against the diver’s neck. The fit of the neoprene neck dam may be made larger by trimming. Only trim a maximum of ¼” at a time; trimming too much will result in a loose fit.

**⚠ WARNING**

Pulling the neck dam over the diver’s head can be difficult. Stretching (expanding) the seal and placing it part way over the head can help reduce the force needed to install the seal. Proper training is necessary to install the neck seal over the diver’s head and onto his neck. Although the possibility is very remote, injury may result if this procedure is not done properly. If a diver does not know how to don the neck dam, he must seek proper instruction before proceeding.



NOTE

If you must trim the neck dam, be careful not to trim off too much material. The neck dam must fit snugly. While it may be a bit uncomfortable out of the water, and may feel snug, once in the water the neck dam will loosen slightly due to compression of the neoprene foam.

### 1.7.8 Reducing Carbon Dioxide

It is important to reduce the volume of air/gas space that the diver is breathing through. To enable this, a rubber oral nasal mask is located inside the helmet to fit over the diver's nose and mouth. The oral nasal attaches to the regulator mount nut. This separates the breathing gas flow from the larger gas space on the interior of the helmet, and this in turn reduces carbon dioxide buildup. Carbon Dioxide (CO<sub>2</sub>) can also build up inside the helmet if regular ventilation does not take place.

#### ⚠ WARNING

**Always be sure the oral nasal valve is properly mounted in the oral nasal mask. If the valve is mounted improperly or is absent this can lead to a higher CO<sub>2</sub> level inside the helmet. A higher CO<sub>2</sub> level can cause dizziness, nausea, headaches, shortness of breath, or blackout.**

### 1.7.9 Communications

In Kirby Morgan helmets (with the exception of the SL 17B and 17C), both earphones and microphone are wired in parallel to the communications module. This module allows for rapid replacement of the entire communications system. The module can be equipped with either a waterproof connector, or binding posts for bare wire connection.

Kirby Morgan uses only high quality speakers and microphones in its communication system, to help ensure the clearest possible communications.

### 1.7.10 Equalizing the Middle Ear

A nose block device allows the diver to block his nose to provide an overpressure in his middle ear for equalization. The blocking pad on the inside of the oral nasal mask is attached to a shaft which passes through a packing gland to the out-

side of the helmet. A knob attached to the end of the shaft can be pushed in to slide the pad under the diver's nose.

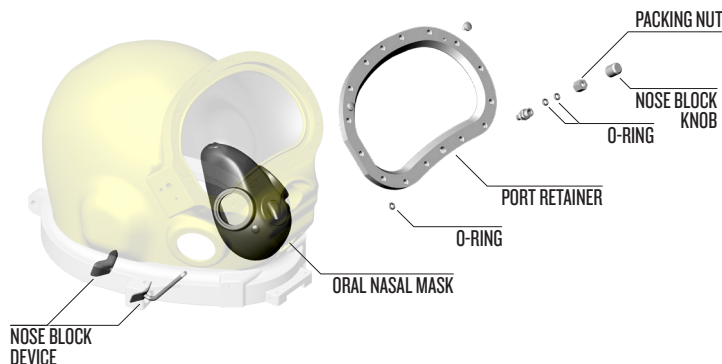

When not needed, the knob is pulled out so the pad does not rub under the diver's nose. The pad may also be turned upside down (to provide more clearance under the diver's nose) by rotating the shaft.

### 1.7.11 Face Port or Viewing Lens

The face port or viewing lens is extremely strong clear polycarbonate plastic which is easily removable for replacement. An O-ring, located under the lens, seals the lens to the viewport recess in the helmet shell.

#### ⚠ DANGER

**The port retainer screws must be tightened to proper torque specifications per the instructions in this manual. See "Torque Specs" module for proper torque specifications. Do not over tighten. This could lead to port failure and helmet flooding. Drowning could result.**

### 1.7.12 SuperLite® 17B Latch Catch Assembly, Pull Pin

The latch catch assembly includes the pull pin and safety pin. The purpose of this assembly is to ensure that the neck clamp assembly remains securely fastened around the base of the helmet, so the helmet remains on the diver. This arrangement functions in a similar manner to the old "dummy pin" on a heavy gear helmet.

All SuperLite® 17B helmets currently manufactured by KMDSI have the Pull Pin Latch Catch Assembly, part number 505-010 (brass) or 505-011 (chrome) on the helmet to lock the Yoke in position. The mounting system for the Pull Pin

Latch Catch Assembly is identical to the old style Push Pin Latch Catch Assembly, P/N 505-015 which has been obsolete since early 1995.

Each Pull Pin Latch Catch Assembly is shipped with a Safety Pin, Part Number 535-900 which we recommend be used when the user requires a two step release system on the helmet. It can be used with or without a cord attached to prevent loss of the Safety Pin when not in use. All Pull Pin Latch Catch Assemblies, P/N 505-010 or 505-011, which are sold as spare or replacement parts include this Safety Pin, P/N 535-900.

The Latch Catch is designed so that in the event that the pin is pulled and the yoke drops down, the neck clamp will remain closed. It acts as two separate locks.



*Old latch catch assembly.  
This device should no longer be used.*



*Current latch catch assembly with safety pin.*

drilled and tapped holes that are provided. These holes are plugged with blanking screws when a new helmet is shipped from the factory.



*The KMDSI Welding Lens for Kirby Morgan helmets (KMDSI P/N 525-403)*

### **⚠ CAUTION**

**Be sure to use only the mount screws provided with the weld lens assembly. Longer screws can damage the port retainer mounting inserts and cause the face port O-ring to leak.**

The weld lenses are standard  $2 \times 4 \frac{1}{2}$  inches or  $4 \frac{1}{2} \times 5 \frac{1}{2}$ , identical to the lenses used in topside welding hoods. They may be replaced quickly without tools.

## **1.8 Accessories**

### **1.8.1 Eye Protection for Welding**

The Welding Lens assembly (Part #525-403) or the Weld Shield Assembly (Part #525-400) may be installed on the port retainer using the pre-



*The KMSDI Weld Shield Assembly  
(KMSDI P/N 525-400)*

### 1.8.2 Hot Water Shroud Kit and Water Shroud Kits

KMSDI manufactures a hot water shroud kit suitable for most helmet models, due to the size and shape differences. Helmets that won't accept a hot water shroud are the KM 47 and KM 77. For other helmets there are specific water shrouds, part number 525-100 (for 17B, 17C, 27 and 37) part number 525-390 (for KM 37SS), water shroud part number 525-756 (for KM Diamond) or water shroud part number 525-761 (for the KM 97). For the 17B, 17C, 27 and 37, the shroud completely encases the side block, bent tube assembly, and demand regulator to provide efficient gas heating for especially deep or cold dives. Heating the diver's breathing gas is especially important in cold water or when breathing mixtures of helium and oxygen.



*The hot water shroud, P/N 525-100 is recommended  
for deep mixed gas diving.  
(Not compatible with all models)*



*The water shroud kit for the KM 37SS P/N 525-390 can be used for both traditional hot water applications and in dirty or debris laden water, using a constant water supply for increased protection of key helmet components.*



*The water shroud kit for the KM Diamond P/N 525-756 can be used for both traditional hot water applications and in dirty or debris laden water, using a constant water supply for increased protection of key helmet components.*



*The water shroud kit for the KM 97 P/N 525-761 can be used for both traditional hot water applications and in dirty or debris laden water, using a constant water supply for increased protection of key helmet components.*

**1.8.3 Special Regulator Tools for the SuperFlow® and the SuperFlow® 350**

Five special tools are available for internal adjustment of the demand regulator assembly: the inlet valve holder, regulator adjustment wrench,

socket wrench, regulator mount nut socket wrench and castle wrench. These three wrenches make regulator adjustment much easier. The tools come in a convenient, wallet sized pouch with instructions. (P/N 525-620). This tool kit ships standard with every Kirby Morgan helmet equipped with the SuperFlow® or the SuperFlow® 350 regulator.



*The Regulator Tool Kit for the SuperFlow® or the SuperFlow® 350 regulator, Part #525-620.*

**1.8.4 Special Regulator Tools for REX® Regulator**



A special tool kit, Part #525-768 is available that will assist you in removing and adjusting the REX® regulator on the Kirby Morgan 47 or 77



helmet. This tool kit ships standard with every new KM 47 or 77 helmet.

Use a brush with a soft handle, made from brass or plastic, to avoid damage to the critical internal bore of the main tube when cleaning it.

### **⚠ WARNING**

**When purchasing spare parts, always insist on Kirby Morgan Genuine Parts. Although other parts may look the same, they may not be manufactured to the same standards of quality. Improperly manufactured parts can cause accidents.**

## **1.9 Helmet Transport And Storage**

### **1.9.1 Transport**

The following images used in this section for helmet transport and storage are generic, as all CE certified helmets are shipped in the same manner.

- The type of package is a cardboard box with air filled pillows with Styrofoam inserts to stabilize the helmet;
- The weight of the box is usually 40 pounds (18 Kg);
- The package dimension is 18 × 18 × 15 inches (460 × 460 × 380 mm);
- One helmet is packed per box;
- The helmets are sent to dealers by air or truck, depending on dealer request.



*Packaging step 1*



*Packaging step 2*



*Packaging step 3*



*Packaging step 4*



Packaging step 5



Packaging step 6

**eight months**, an “Annual Inspection” in accordance with Check List Appendices A2.1 is recommended for the helmet/mask after storage, prior to diving.

For **post-dived helmets** in storage **longer than three weeks**, a “Monthly Inspection” in accordance with Check List Appendices A2.2 is recommended for the helmet/mask after storage, prior to diving.

## 1.10 Band Mask® Transport And Storage

### 1.10.1 Transport

- The type of package is a cardboard box with air pillows or packing pillows paper packaging to stabilize the Band Mask®.

The weight of the box is usually:

- 15 pounds (6.8 Kg);

The package dimensions are:

- A 12 × 12 × 12 inches (305 × 305 × 305 mm) goes into a 14 × 14 × 14 inches (357 × 357 × 357 mm);
- The Band Masks® are sent to dealers by air or truck, depending on dealer request.

### 1.9.2 Storage

For your records: (*Company equipment log and/or diver's personal log*) be aware that the first day a helmet is used is its **1st DIVE DATE**. This date begins the time clock for maintenance and inspections. This date should be the first entry into the maintenance and repair log book that comes with the KMDSI helmet/mask. It is also recommended to add the entry into the diver's log book.



**NOTE**

For **new helmets** in the box (inspected upon receipt, but never dived), stored in inventory **longer than one year**, a “Monthly Inspection” in accordance with Check List Appendices A2.2 should be performed.

For **post-dived helmets** in storage **longer than**



*Packaging of the BandMask, step 1.*



*Packaging of the BandMask, step 3.*



*Packaging of the BandMask, step 2.*



*Packaging of the BandMask, step 4.*



*Final packaging of the BandMask*

### 1.10.2 Storage

For your records: (*Company equipment log and/or diver's personal log*) be aware that the first day a helmet is used is its **1st DIVE DATE**. This date begins the time clock for maintenance and inspections. This date should be the first entry into the maintenance and repair log book that comes with the KMDSI helmet/mask. It is also recommended to add the entry into the diver's log book.



**NOTE**

For **new BandMasks®** in the box (inspected upon receipt, but never dived), stored in inventory **longer than one year**, a "Monthly Inspection" in accordance with Check List Appendices A2.2 should be performed.

For **post-dived BandMasks®** in storage **longer than eight months**, an "Annual Inspection" in accordance with Check List Appendices A2.1 is recommended for the helmet/mask after storage, prior to diving.

For **post-dived BandMasks®** in storage **longer than three weeks**, a "Monthly Inspection" in accordance with Check List Appendices A2.2 is recommended for the helmet/mask after storage, prior to diving.

### 1.10.3 Helmet Carrying Bag

To help protect your helmet, the helmet carrying bag should be used to transport and store your helmet between jobs.



*The KMDSI Helmet Bag, Part #500-901.*

The KMDSI bag is made from extra heavy duty, black, ripstop nylon. The bottom of the bag is padded for additional protection. Grommeted drain holes allow the bag to breathe. The bag is also equipped with large carrying straps and side pockets. The bag is not intended for shipping your helmet as air cargo.

### 1.11 Use of Kirby Morgan Original Replacement Parts

Users of Kirby Morgan life support equipment are cautioned to always use Kirby Morgan original replacement parts. Parts manufactured by third party companies can cause accidents.



*Look for the Kirby Morgan logo on Kirby Morgan products. This is your assurance that you are getting genuine Kirby Morgan replacement parts.*

