

SuperFlow® 450 Regulator

Contents

SF450-1	1.1 SuperFlow® 450 Stainless Balanced Regulator	SF450-8	1.1.6 SuperFlow® 450 Regulator Removal
SF450-1	1.1.1 General	SF450-10	1.1.7 SuperFlow® 450 Disassembly
SF450-1	1.1.2 SuperFlow® 450 Performance	SF450-12	1.1.8 Assembly of the SuperFlow® 450 Regulator
SF450-1	1.1.3 SuperFlow® 450 Demand Regulator Test for Correct Adjustment, Fully Assembled	SF450-12	1.1.8.1 Assembly of the Flex Knob
SF450-2	1.1.4 Adjusting the SuperFlow® 450	SF450-13	1.1.9 Assembly of SuperFlow® 450 Regulator
SF450-3	1.1.5 SuperFlow® 450 Demand Regulator Bias Adjustment Field Service with Demand Regulator on Helmet	SF450-18	1.1.10 SuperFlow® 450 Regulator Installation

1.1 SuperFlow® 450 Stainless Balanced Regulator

1.1.1 General

The SuperFlow® 450 is an exceptionally compact, high performance regulator.



NOTE: When storing the helmet for any length of time, ensure that the Flex Knob is turned “out” fully counterclockwise to avoid stressing the bias spring. This will prolong the life of both the inlet valve, seat, and bias spring.

1.1.2 SuperFlow® 450 Performance

The SuperFlow® 450 is an all Stainless Steel regulator of a balanced design that offers a slightly higher degree of breathing performance and ex-

treme breathing rates, greater than the non balanced SuperFlow® regulator.

1.1.3 SuperFlow® 450 Demand Regulator Test for Correct Adjustment, Fully Assembled

To maintain optimum performance of the demand regulator, it should be checked for proper function and adjustment prior to commencement of diving each diving day, in accordance with the KMDSI Daily Set Up and Functional Checklist. See the Dive Lab website for the latest checklists at www.divelab.com.

Check the regulator for adjustment and proper function with the assembly complete, and supplied with a breathing gas supply pressure of 135 to 150 p.s.i.g.

NOTE: 135 to 150 p.s.i.g. over ambient is the standard supply pressure to be used when adjusting all KMDSI helmets and band-mask equipped with the SuperFlow® 450 regulator.

1) Rotate the Flex Knob in, towards the regulator body, until a clicking can be heard with each revolution of the knob. This is an audible indication the adjustment spring tension has reached its maximum. The adjustment knob will never

bottom out or stop turning in this direction, so listen carefully for this indicating click.

2) Ensure the supply pressure is connected and properly adjusted to 135 to 150 p.s.i.g.

3) Turn on the gas supply.

4) Rotate the Flex Knob out counterclockwise slowly, three full turns.

5) Lightly depress the purge button several times and ensure the gas flow is stable.

6) Push in gently on the cover of the regulator. There should be $\frac{1}{8}$ "– $\frac{1}{4}$ " free travel in the button before gas flow starts. When the button is fully depressed, a strong surge of gas must be heard.

7) If the purge button travels less than $\frac{1}{8}$ " or greater than $\frac{1}{4}$ " before free flow is heard, the demand regulator requires internal adjustment, per "1.1.4 Adjusting the SuperFlow® 450" on page SF450-2.

1.1.4 Adjusting the SuperFlow® 450

Tools required:

- Flat Blade Screwdriver
- $\frac{1}{16}$ inch Open-End Attachment on Torque Wrench
- $\frac{7}{8}$ inch Open-End Attachment on Torque Wrench
- $\frac{7}{8}$ inch Open-End Wrench
- 1 inch Open End Wrench
- $\frac{1}{4}$ " to $\frac{5}{16}$ " Dowel Rod Sharpened by Pencil Sharpener

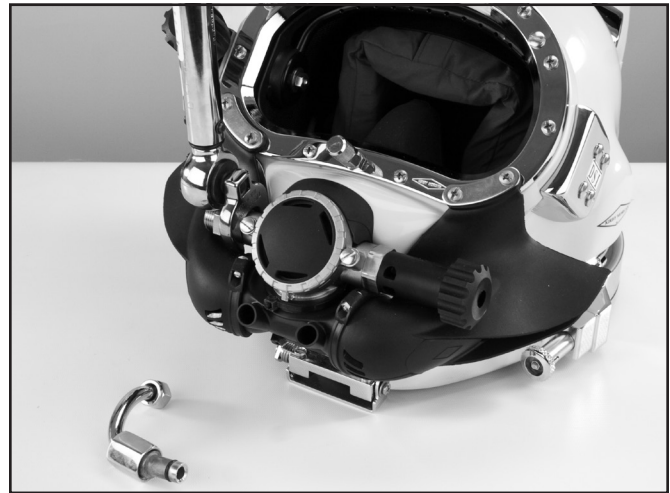

Remove the bent tube and the bent tube adapter on the regulator inlet.

1) Remove the bent tube assembly from the helmet.

2) Remove the bent tube adapter from the regulator inlet.

3) Through the regulator inlet side, insert a flat head screwdriver into slot in the end of the adjustment nipple.

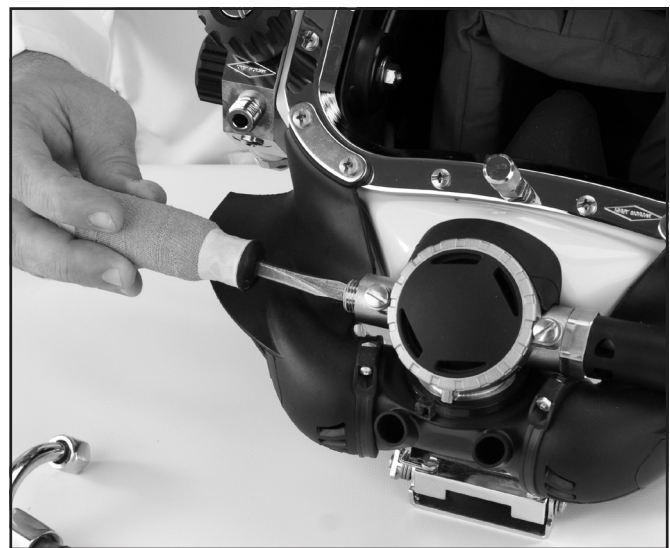

Turn the adjustment nipple 1/16 of a turn at a time to adjust the flow of the regulator.

4) If the regulator does not flow when the regulator cover is pushed in the $\frac{1}{8}$ "– $\frac{1}{4}$ ", turn the adjustment nipple **OUT** $\frac{1}{16}$ of a turn. Small adjustments only are needed to tune the regulator. Reconnect the low pressure hose, pressurize it and test again.

5) If the regulator begins to free flow very easily, turn the adjustment nipple IN $\frac{1}{16}$ of a turn. Small adjustments only are needed to tune the regulator. Reconnect the low pressure hose, pressurize it and test again.

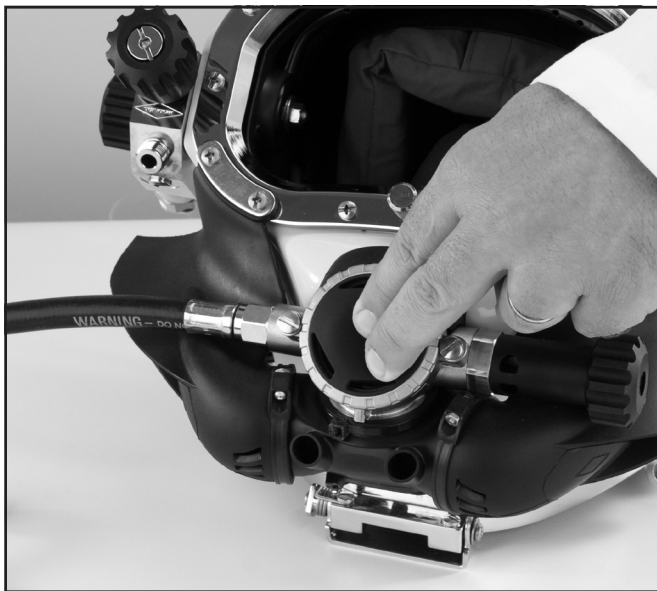

Before you reinstall the bent tube, connect the low pressure hose to the regulator and pressurize it again. Push in on the regulator cover 1/4 inch. The regulator should just begin to free flow if it is properly adjusted.

6) If you are unable to obtain a proper adjustment with the regulator following this procedure, you will need to disassemble the regulator to check the condition of the lever.

7) Once the regulator is properly adjusted, reinstall the bent tube adapter and O-ring. Torque the adapter. See "Torque Specs" module.

8) Reinstall the bent tube assembly as per "1.3.3 Installation of the Bent Tube Assembly" on page BNT-4.

1.1.5 SuperFlow® 450 Demand Regulator Bias Adjustment Field Service with Demand Regulator on Helmet

It is not necessary to remove the regulator from the helmet to perform field maintenance.

Tools required:

- $\frac{1}{4}$ inch Flat Blade Screwdriver on Torque Wrench

- 1" Open End Attachment on Torque Wrench
- $\frac{1}{4}$ " to $\frac{5}{16}$ " Dowel Rod Sharpened by Pencil Sharpener

1) Remove the bent tube assembly from the helmet, per "1.3.1 Removal of the Bent Tube Assembly" on page BNT-4.

2) Using a $\frac{7}{8}$ " wrench, remove the bent tube adapter and O-ring.

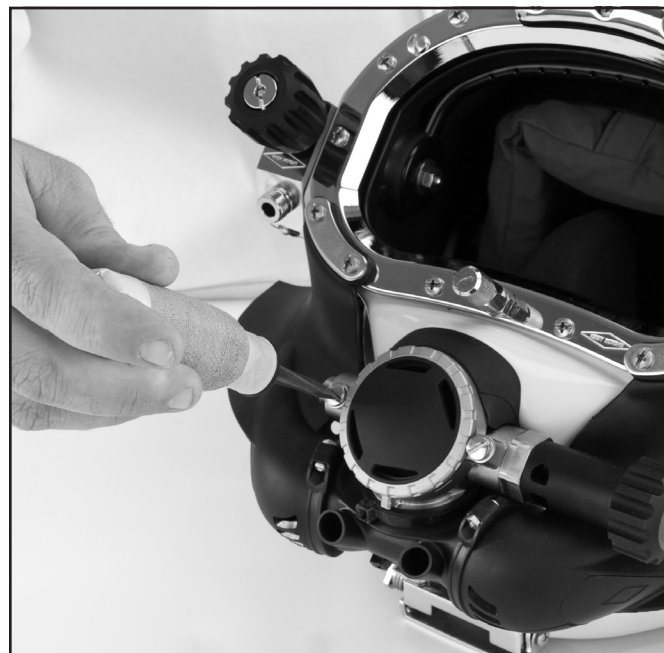

Remove the screws and washers on either side of the cover.

3) Remove the screws and washers on either side of the regulator cover.



Unscrew the cover retaining ring and remove the cover.

4) Unscrew the cover retaining ring.

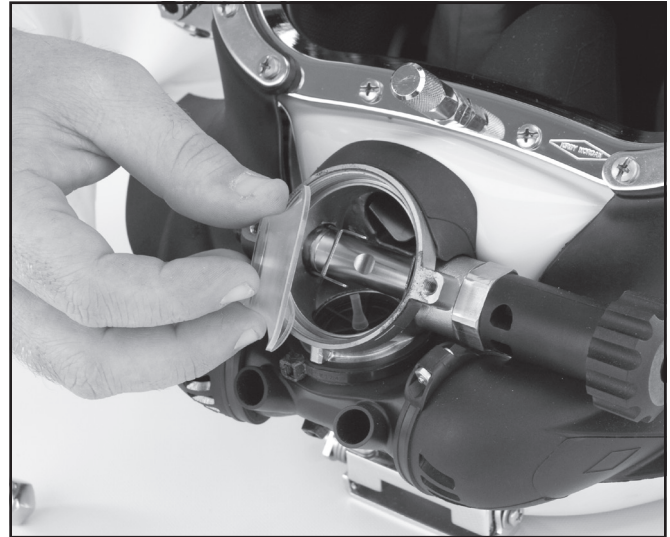

Remove the diaphragm and inspect it carefully. If it is torn or punctured it must be replaced.

5) Remove the cover and diaphragm. Inspect the diaphragm for holes or tears. If it is torn or punctured it must be replaced. Inspect the interior of the regulator for foreign matter and remove if necessary.

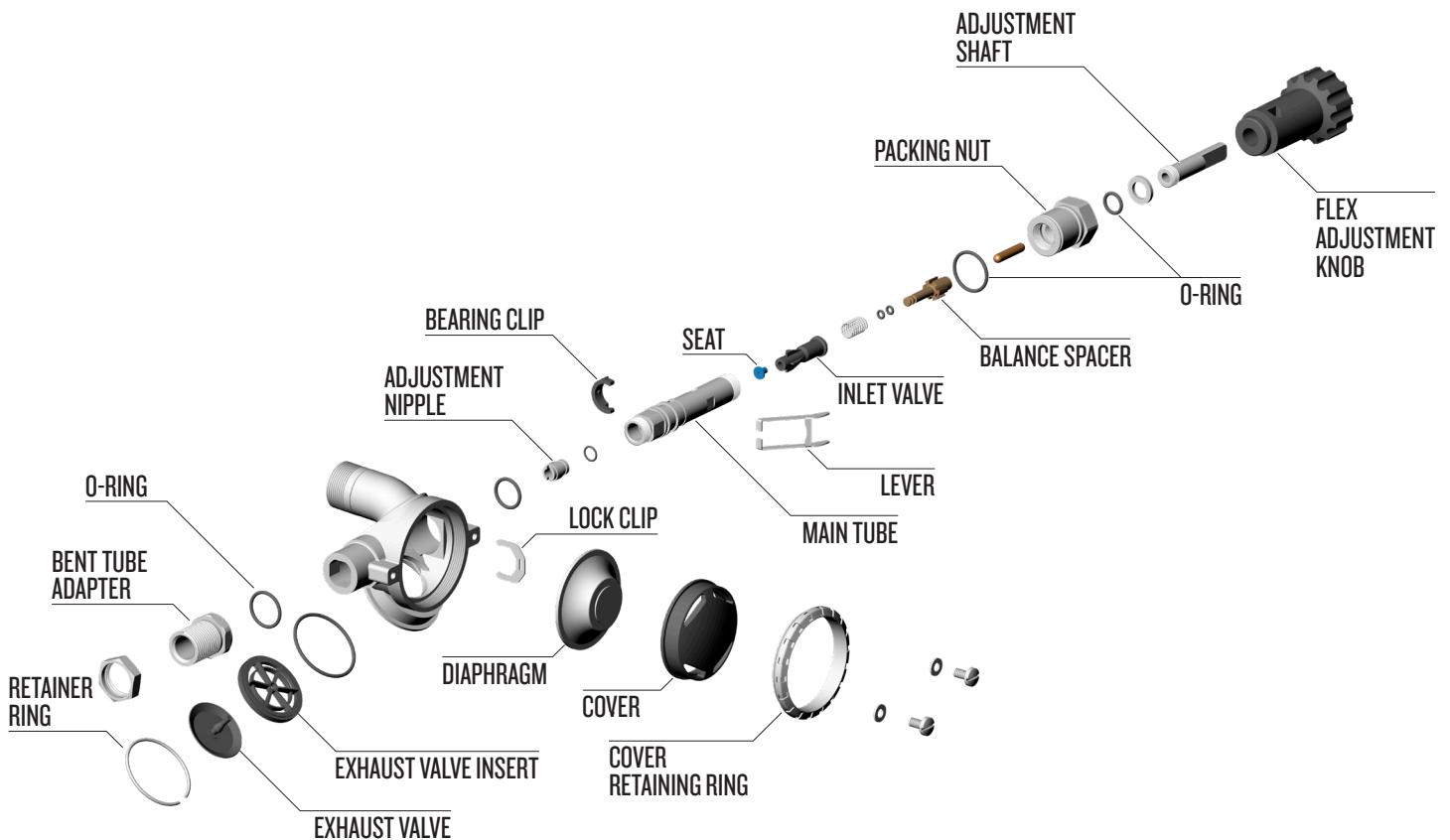

Exploded view of SuperFlow® 450 regulator.



The lock clip must be removed to service the internal O-rings in the regulator.

6) Carefully insert the tip of a flat blade screwdriver into the slot at the top of the lock clip to loosen it and slide the clip away from the regulator main tube.

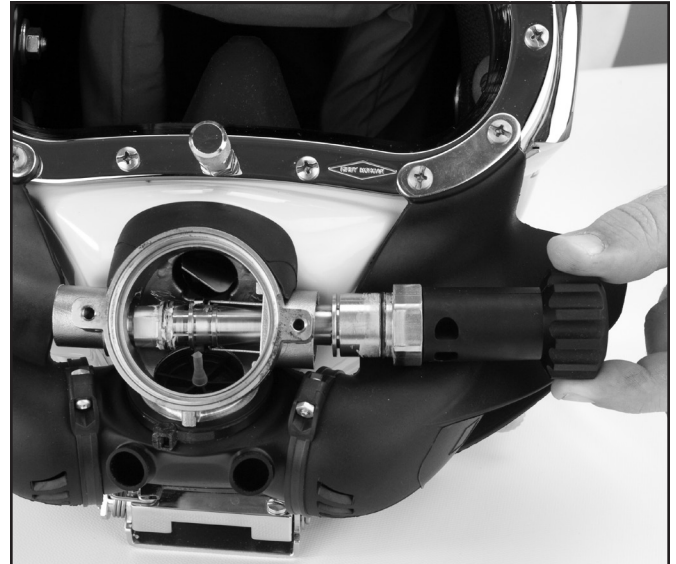

When you pull the flex knob assembly out, the main tube and related parts will follow.

7) Using the 1" open end wrench, loosen the packing nut about 1 turn. Next, while fully depressing the lever arm, grasp the flex knob and pull it straight out from the regulator body. This will remove all of the main components of the regulator valve mechanism as a single, easy to handle unit.

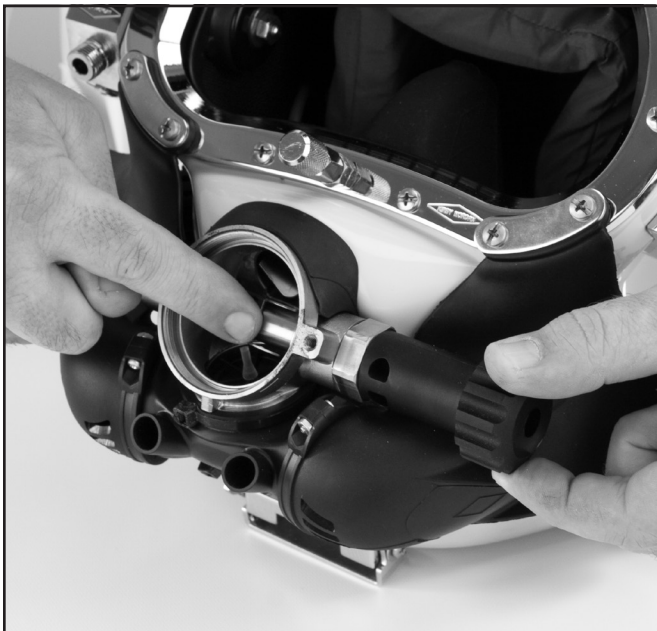

You must hold the lever down to remove all main components as a sub assembly.



Separate the flex knob assembly from the main tube.

8) Unscrew the flex knob assembly from the main tube.



Remove the O-ring from the flex knob packing nut. You can use a credit card, toothpick, or any soft device that will not damage the O-ring or the nut.

9) Remove the O-ring from the flex knob assembly packing nut. Inspect for signs of wear and replace if necessary. Otherwise, if it is in good condition, set it aside for cleaning and lubrication.

10) Remove the lever by gently pulling one leg out from the slot on the main tube, followed by the second leg.

11) Remove the bearing clip from the main tube.

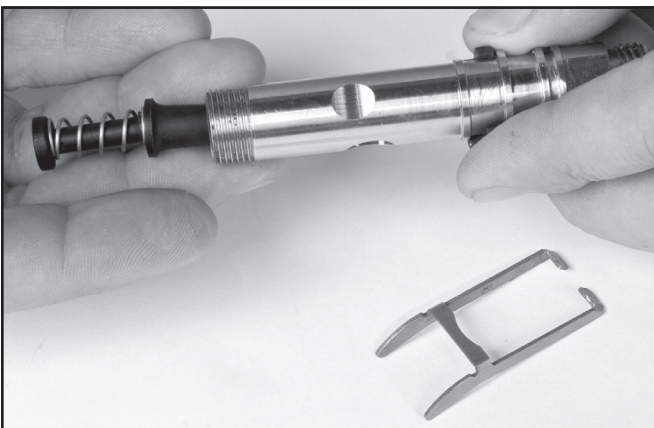

Remove the balance spacer, spring, inlet valve and seat from the main tube.

12) Slide the balance spacer, spring and inlet valve assembly out of the main tube.

13) Unscrew the adjustment nipple (turn it "out") from the main tube. This may require lightly tapping on the tube to dislodge the parts or use the

wooden dowel rod to push it free. Carefully check the nipple O-ring for damage, even small cuts may cause leaking.

14) Inspect all parts for signs of wear or damage and replace if necessary.

15) Clean all parts per "1.3 Routine Maintenance" on page IM-3. Lubricate O-rings and moving parts with a light coating of Christo-Lube®. It is not necessary to disassemble the flex knob assembly.

16) Install the O-ring on the adjustment nipple if you have not already done so. Be sure that the O-ring has been properly lubricated with Christo-Lube®.

17) Install the O-ring onto the main tube.

18) Install the O-ring onto the balance spacer.

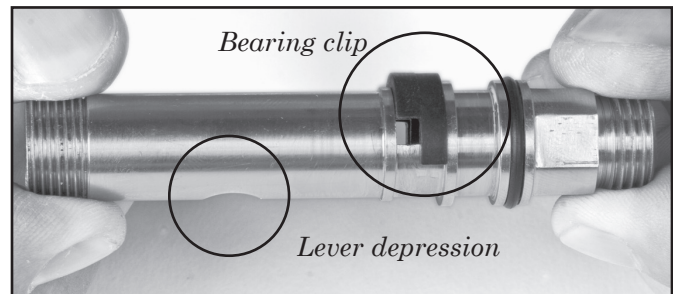

Correct position of bearing clip on main tube.

19) Install the bearing clip onto the outside of the main tube. Note that there is a locating pin on the clip that must engage into the correct hole on the main tube.

The clip is correctly positioned when it is on the side opposite of the depression for the lever on the main tube. The square opening on the main tube must be exposed.

20) Spread the arms of the lever just enough to install it onto the main tube.

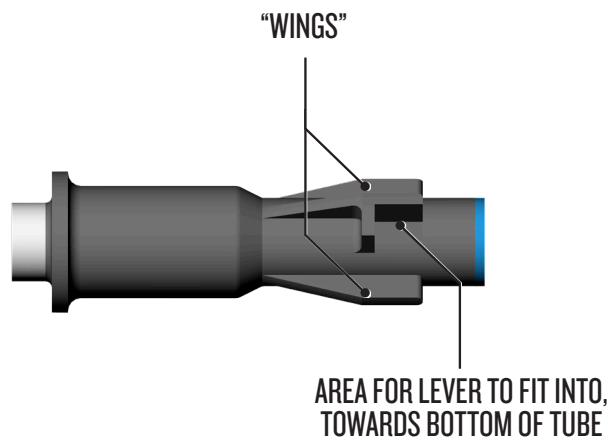

Close-up detail of the inlet valve.

21) Study the features of the inlet valve assembly. There are four “wings” towards one end of the assembly and a bore that creates the balance chamber on the opposite end.

NOTE: The wings that align with the lever arm are the two that have an additional wall for the lever arm to bear on. The valve assembly should be inserted into the main tube with these walls toward the bottom of the regulator tube.

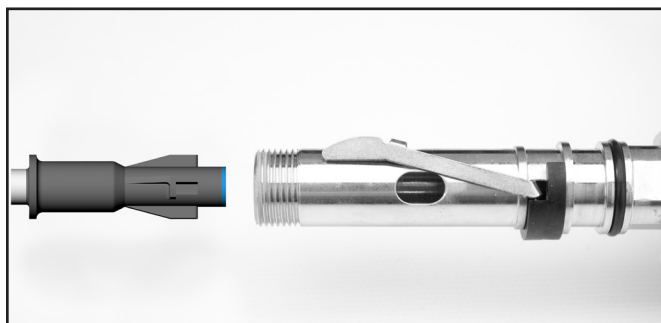

Inserting the inlet valve into the main tube.

22) Using a clean wooden dowel rod, that has been sharpened in a pencil sharpener and inserted into the open end of the inlet valve, align and insert the inlet valve into the main tube, as noted above. If this is done properly, the lever should lift up. If it does not, the valve has not been inserted correctly.

23) While holding the inlet valve in position, pull each arm of the lever outward just slightly until the inlet valve moves further into the main tube, approximately ¼ inch. The dowel rod should move in a bit further, indicating this has occurred and the lever should spring back up.

24) Release pressure on the dowel rod. The lever should fall back to a position against the main tube. Push in gently on the dowel and the lever should rise again to approximately a 45 degree angle. If this does not happen, or the angle is very low, the inlet valve will need to be removed and reinstalled to achieve the correct orientation.

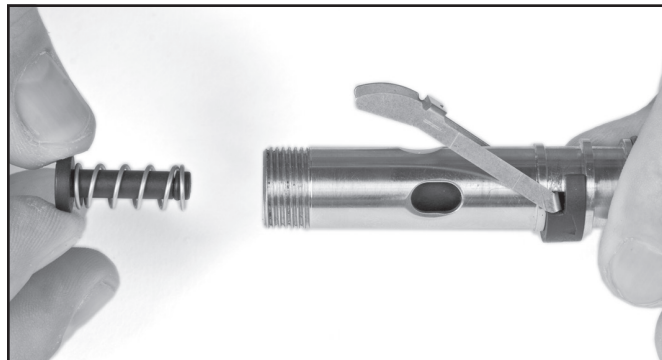

Insert the balance spacer and spring in the main tube. When it is properly installed the spacer will engage the inlet valve.

25) Remove the dowel rod and insert the spring and balance spacer with O-ring into the main tube. Make sure the balance spacer is properly aligned inside the main tube by pushing in on the end of the spacer and slightly turning it with your finger tip, to see that it moves inward (i.e., it engages the hole in the inlet valve).

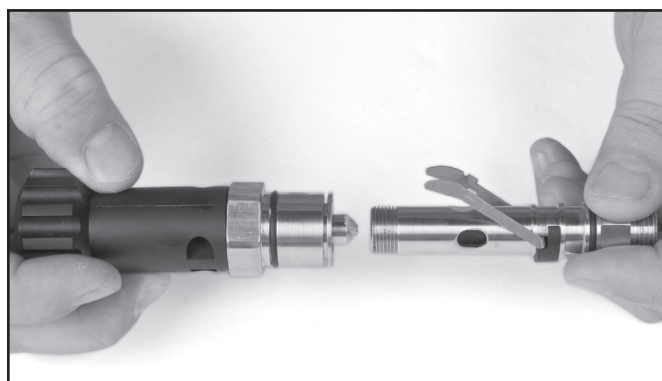

Thread the adjustment knob onto the main tube.

26) Thread the flex knob assembly onto the end of the main tube (closest to the lever arms) until it just stops. Hand tighten the assembly and then back the assembly out one turn.



Thread the adjustment nipple into the main tube.

27) Insert the adjustment nipple into the main tube on the end opposite the adjustment knob. Using a flat blade screwdriver, thread the nipple into the tube slowly.

Tip: As soon as you see any twisting movement or drop of the lever, stop screwing the nipple in. Turn in on the flex knob until an audible click is heard. This is typically very close to optimum adjustment.

28) It is recommended that the regulator sit for 24 hours before any further assembly is completed. This will allow the seat to conform itself correctly to the inlet nipple.

29) Depress the lever down and carefully install this assembly of the main tube and adjustment knob into the regulator until the threaded end of this assembly comes completely through the opposite side of the regulator body, making sure the square flat area aligns to the mating squares in the regulator body.

NOTE: It is important to do steps 30) and 31) in this sequence.



Install the O-ring into the bent tube adapter.

30) Install the O-ring and the bent tube adapter and tighten to 30 inch pounds.

31) Tighten the packing nut at the flex knob with a one inch wrench to 30 inch pounds.

32) Install the lock clip on the main tube.

33) Reinstall the diaphragm, cover and cover retaining ring.

34) Reinstall the bent tube assembly as per "1.3.3 Installation of the Bent Tube Assembly" on page BNT-4. Check the adjustment of the regulator using recommended air pressure. If you followed the, "Tip" noted in step 27) *Insert the adjustment nipple into the main tube on the end opposite the adjustment knob. Using a flat blade screwdriver, thread the nipple into the tube slowly.*, the regulator should be very close if not correctly adjusted.

35) If necessary, adjust the regulator per "1.1.4 Adjusting the SuperFlow® 450" on page SF450-2.

36) Once the regulator is properly adjusted, reinstall the washers and screws that secure the regulator cover and ring. Tighten the screws to 12 inch pounds.

1.1.6 SuperFlow® 450 Regulator Removal

Tools required:

- 1/16 inch Open-end Attachment on Torque Wrench

- 7/8 inch Open-end Wrench, Torque Wrench and 1 3/8 inch Socket
- 1/4 inch Flat Blade Attachment on Torque Screwdriver

1) Remove the bent tube assembly, per "1.2.1 Removal of the Bent Tube Assembly" on page BNT-1.

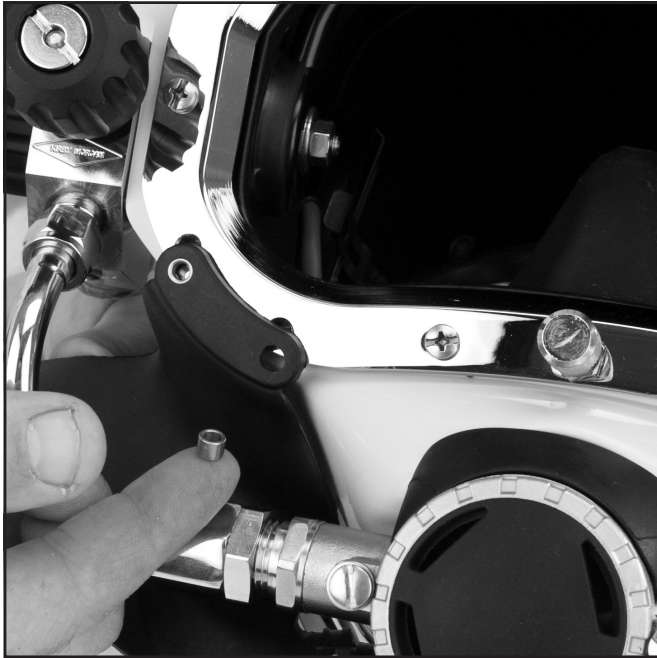

Be sure to remove and set aside the whisker spacers.

- 2) Remove the screws, kidney plates, zinc anodes if present and whisker spacers from the whiskers.
- 3) Remove the nose block device per "Nose Block Assembly Removal" on page FCPRT-6.
- 4) Remove the oral nasal mask per "Oral Nasal Mask Removal" on page ON-1.
- 5) The regulator mount nut is removed along with the sealing O-ring.
- 6) Cut the tie wrap that connects the regulator body to the Quad Valve cover.



Remove the regulator from the helmet.

7) Now the regulator assembly can be pulled out of the helmet.



Separate the regulator from the Quad Valve™ exhaust whiskers.

8) The center section of the exhaust whisker, named the Quad Valve exhaust main body has a tie wrap holding it in place. Remove the tie wrap then stretch the body off the regulator exhaust flange.

1.1.7 SuperFlow® 450 Disassembly

Tools required:

- 1 inch Open End Attachment On Torque Wrench
- ¼inch Flat Blade Attachment On Torque Screwdriver
- ⅜" Dowel Rod Sharpened By Pencil Sharpener

1) Remove the screws and washers on either side of the regulator cover.

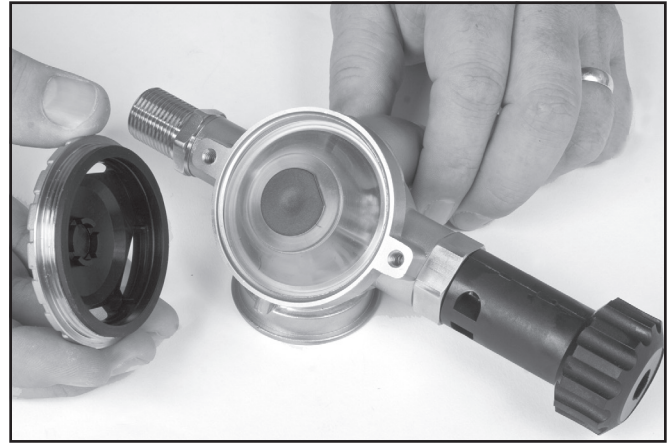

Remove the cover retaining ring and regulator cover.

2) Unscrew the cover retaining ring.

3) Remove the cover and diaphragm. Inspect the diaphragm for holes or tears. If it torn or punctured it must be replaced. Inspect the interior of the regulator for foreign matter and corrosion and clean or replace as necessary.

4) Remove the bent tube adapter and O-ring.

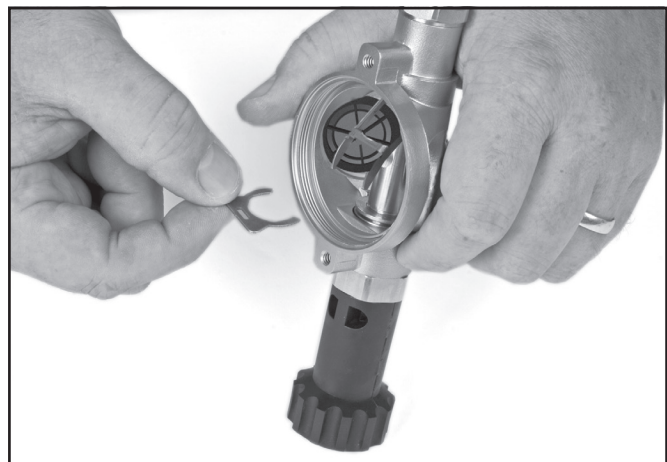

Remove the lock clip from the interior of the regulator.

5) Carefully insert the tip of a flat blade screwdriver in the slot at the top of the lock clip and slide the clip away from the regulator main tube.

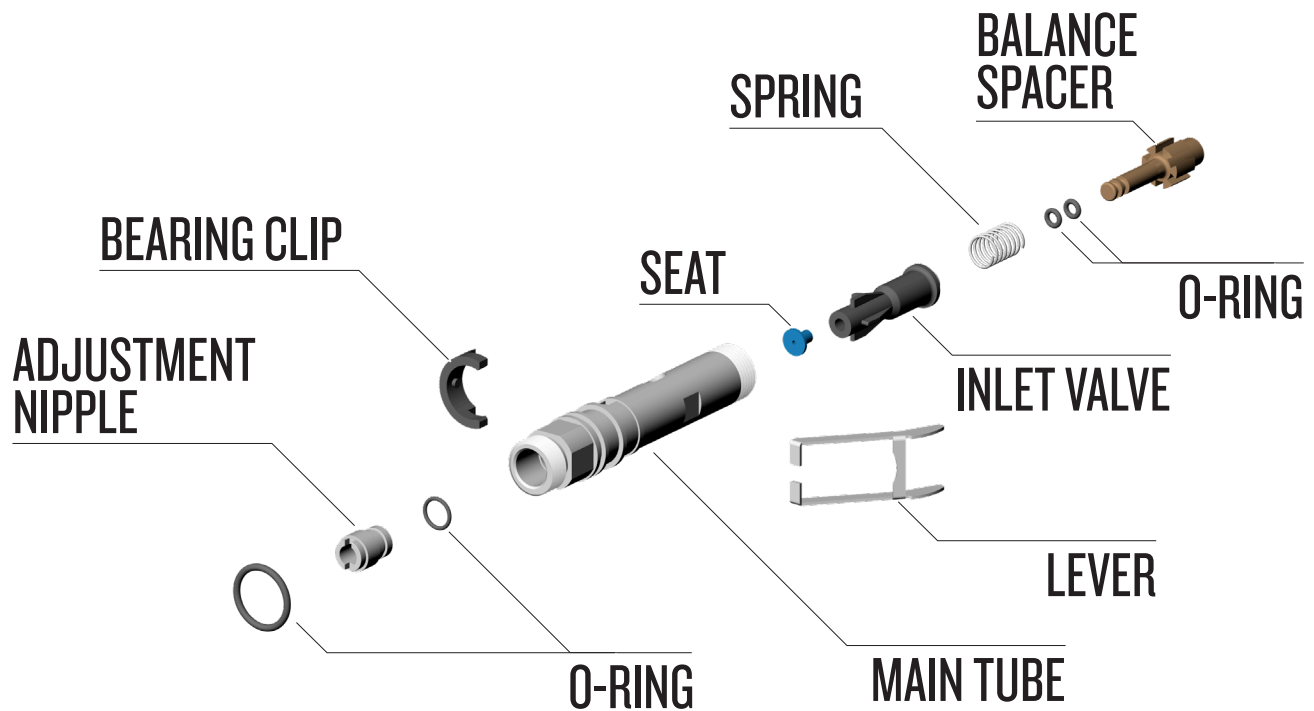

Details of the SuperFlow® 450 main tube and associated parts.

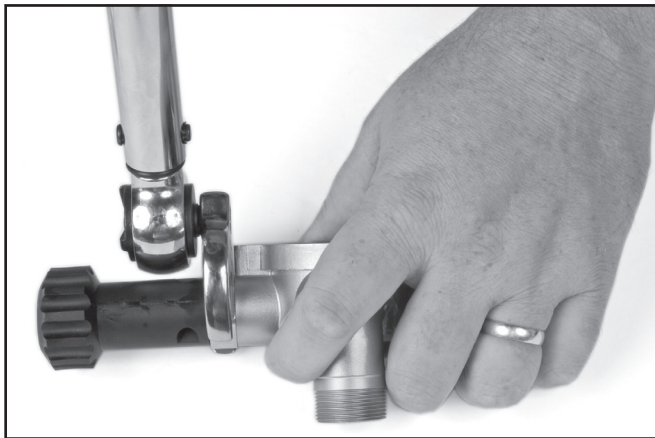

Unscrew the packing nut from the regulator body.

6) Using the 1" open end wrench, loosen the packing nut about one turn. While fully depressing the lever arm, grasp the flex knob and pull it straight out from the regulator body. This will remove all of the main components of the regulator valve mechanism as a single, easy to handle unit.

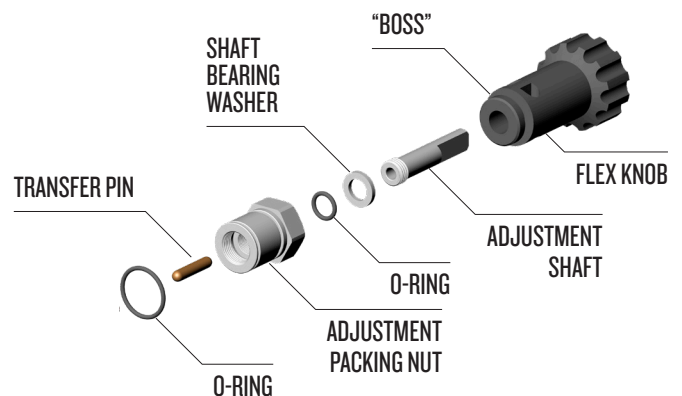

SuperFlow® 450 flex knob assembly.

7) Unscrew the flex knob assembly from the main tube.

8) Loosen the packing nut on the flex knob and unscrew the packing nut. Hold the packing nut while turning the flex knob clockwise. You will notice the internal adjustment shaft will travel outward AWAY from the packing nut.

If the shaft does not fall free from the knob, after about ten full turns, it will be possible to grasp the chamfered tip of the shaft and pull it straight out from the assembly.

9) Remove the adjustment shaft from the flex knob. With the shaft out, grasp the packing nut with one hand and the flex knob with the other and bend. There is a boss on the knob that will pop loose from the packing nut.

10) Remove the O-rings from the adjustment shaft and packing nut.

11) Remove the lever by gently pulling one leg out from the slot on the main tube, followed by the second leg.

12) Remove the bearing clip from the main tube.

13) Slide the balance spacer, spring, inlet valve assembly out of the main tube.

14) Unscrew the adjustment nipple (turn it "out") from the main tube. This may require lightly tapping on the tube to dislodge the parts or use the wooden dowel rod to push it free. Carefully check the nipple O-ring for damage, even small cuts may cause leaking.

15) Remove the O-ring from the balance spacer.

16) Remove the O-ring from the main tube.

17) Remove the retainer ring from the regulator body.

18) Remove the exhaust valve insert from the regulator body and separate the exhaust valve from the insert.

19) Inspect all parts for signs of wear or damage and replace if necessary.

20) Clean all parts per "1.3 General Cleaning & Inspection Procedures" on page GENPRE-4. Lubricate O-rings and moving parts with a light coating of Christo-Lube®.

1.1.8 Assembly of the SuperFlow® 450 Regulator

Tools required:

- 1¹/₁₆ inch Open-end Attachment on Torque Wrench

- 7/8 inch Open-end Wrench, Torque Wrench and 1 3/8 inch Socket
- 1/4 inch Flat Blade Attachment on Torque Screwdriver

1.1.8.1 Assembly of the Flex Knob

1) Lubricate the larger packing nut O-ring with Christo-Lube® and install onto external O-ring groove of the packing nut.

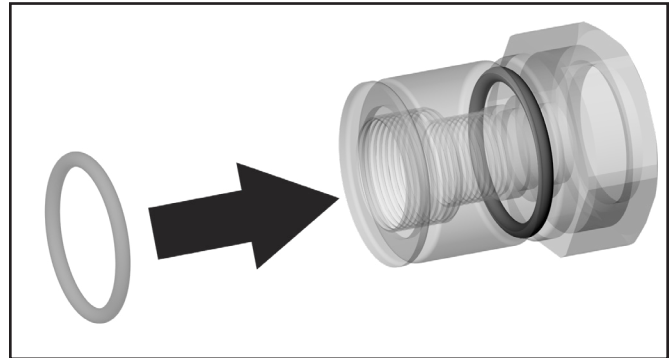

Install the larger O-ring over external packing nut groove

If the smaller internal packing nut O-ring required replacement then follow step 2), otherwise, skip to step 3).

2) Lubricate the smaller packing nut O-ring with Christo-Lube® and install into internal O-ring groove of packing nut.

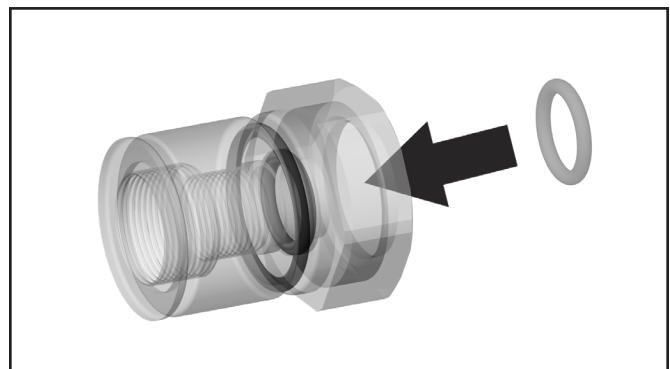

Install the smaller O-ring into internal packing nut groove

3) Begin installing the flex knob into the groove of the packing nut. Place the packing nut into a vise and, using a wide slotted screwdriver, push the rest of the flex knob into the packing nut.



Place packing nut in vise and use a slotted screwdriver to insert flex knob

4) Next, lubricate the threads on the adjustment shaft with Christo-Lube® and insert into the flex knob. Push on the adjustment shaft's end while turning the flex knob to engage threads. Turn the flex knob counterclockwise until the flex knob stops



Lubricate threads on adjustment shaft with Christo-Lube® and insert into flex knob

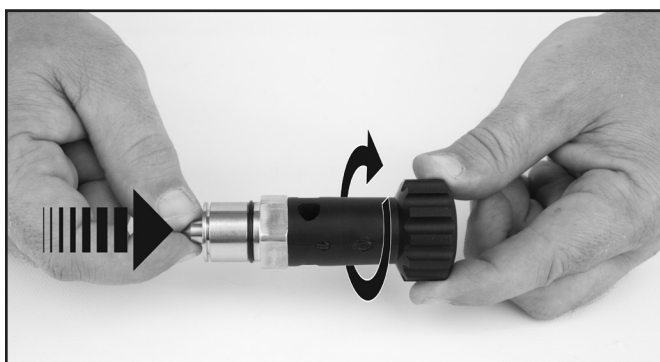

Push in on the adjustment shaft while turning the flex knob counterclockwise to engage threads

1.1.9 Assembly of SuperFlow® 450 Regulator



The regulator body must be clean and free of foreign matter.

1) Inspect the interior of the regulator body and make sure that it is clean and there is no foreign matter or corrosion.

2) Install the O-ring into the regulator body.



Install the O-ring and valve insert.

3) Place the exhaust valve insert into the regulator body. The insert must be oriented so that it seals against the O-ring and the exhaust valve will mate properly with the insert.

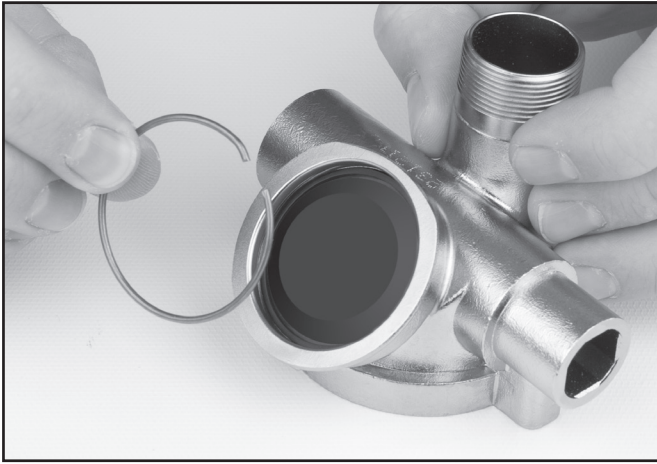

Install the retainer ring.

4) Use a flat blade screwdriver to push the retainer ring into the opening in the regulator body for the exhaust valve insert. The ring should lock into place. Make sure it is pressed into the groove completely. This is extremely important to prevent the exhaust components from becoming dislodged.

5) Install the exhaust valve into the exhaust valve insert. Cut off any excess tail from the exhaust valve that protrudes into the regulator body.

To test to see if the insert is installed properly, try to spin the insert. It should not turn. You should not be able to dislodge the insert by hand. Friction between the insert, the O-ring and the regulator body should hold the insert in its proper position.

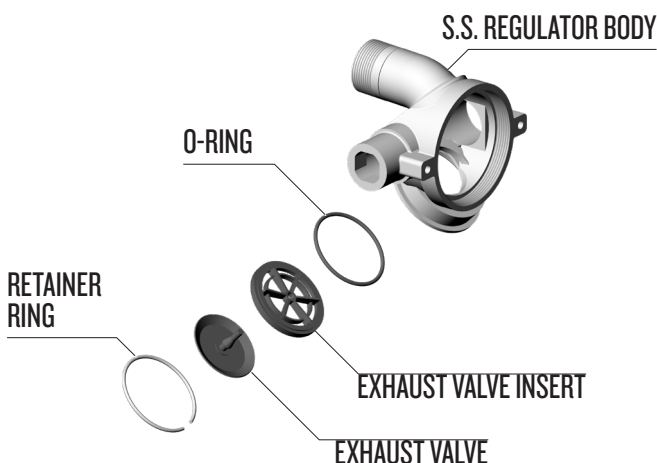

SuperFlow® 450 exhaust valve mechanism.

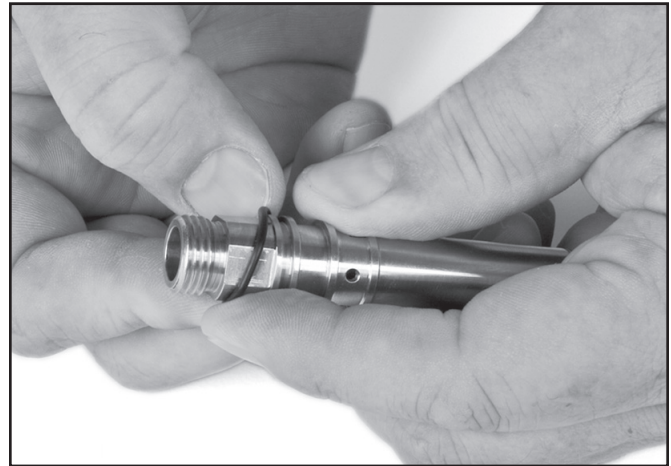

Install the O-ring on the main tube.

6) Install the O-ring on the main tube. Lubricate with Christo-Lube®.

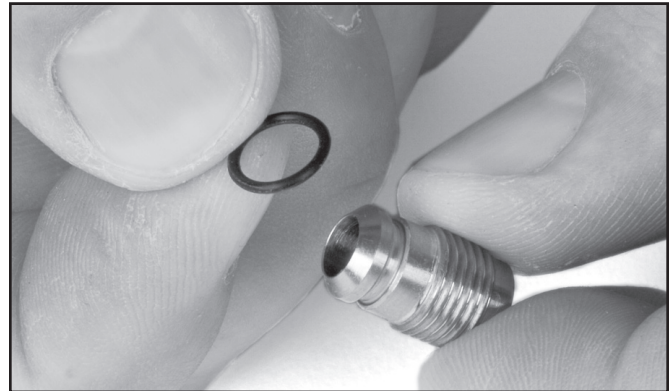

Install the O-ring on the inlet nipple.

7) Install the O-ring on the adjustment nipple. Lubricate with Christo-Lube®.

8) Install the O-ring on the balance spacer. Lubricate with Christo-Lube®.

9) Install the bearing clip on the main tube. Note that there is a locating pin on the clip that must engage the correct hole on the main tube. The clip is correctly positioned when it is on the side opposite of the depression for the lever on the main tube.

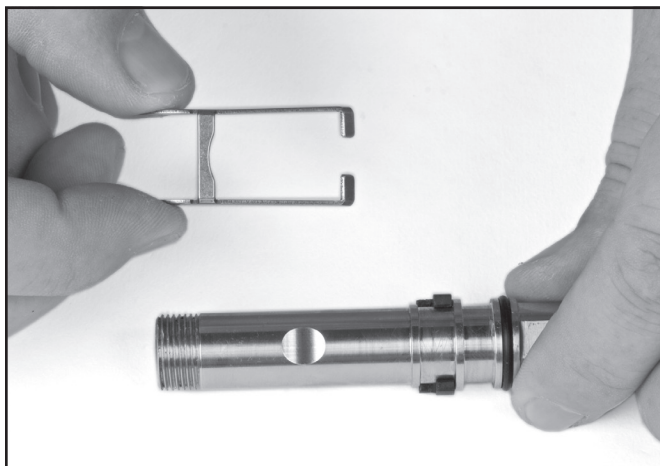

Install the lever on the main tube. Note the bearing clip fastens on the opposite side of the tube.

10) Spread the arms of the lever just enough to install it on the main tube.

11) Study the features of the inlet valve assembly. There are four “wings” towards one end of the assembly and a bore that creates the balance chamber on the opposite end. The wings that align with the lever arm are the two that have an additional wall for the lever arm to bear on. The valve assembly should be inserted into the main tube with these walls toward the bottom of the regulator tube. See diagram "Close-up detail of the inlet valve." on page SF450-7

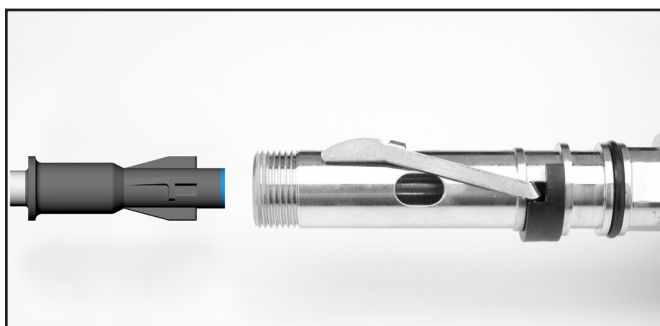

Install the inlet valve into the main tube.

12) Using a clean wooden dowel rod, that has been sharpened in a pencil sharpener and inserted into the open end of the inlet valve, properly align and insert the inlet valve into the main tube. If this is done properly, the lever should lift up. If it does not, the valve has not been inserted correctly.

13) While holding the inlet valve in position, pull each arm of the lever outward just slightly until

the inlet valve moves further into the main tube, approximately ¼ inch. The dowel rod should move in a bit further, indicating this has occurred.

14) Release pressure on the dowel rod. The lever should fall back to its normal position against the main tube. Push in gently on the dowel and the lever should rise again. If this does not happen, the inlet valve is not installed correctly and must be reinstalled.

15) Remove the dowel rod and insert the spring and balance spacer into the main tube. Make sure the balance spacer is properly aligned inside the main tube by pushing in on the end of the spacer and slightly turning it with your finger tip, to see that it moves inward (i.e., it engages the hole in the inlet valve).

16) Install the O-ring in the packing nut.

17) Fit the flattened end of the adjustment shaft into the flex knob.

18) Screw the adjustment shaft into the packing nut until it clicks.

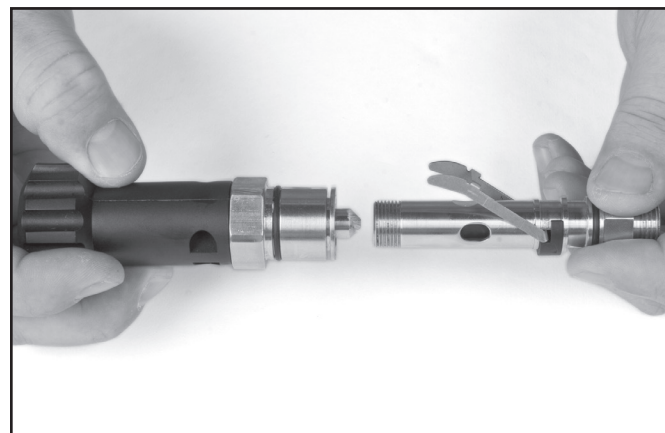

Screw the flex knob assembly onto the main tube.

19) Screw the packing nut and the entire flex knob assembly onto the main tube until it is hand tight.

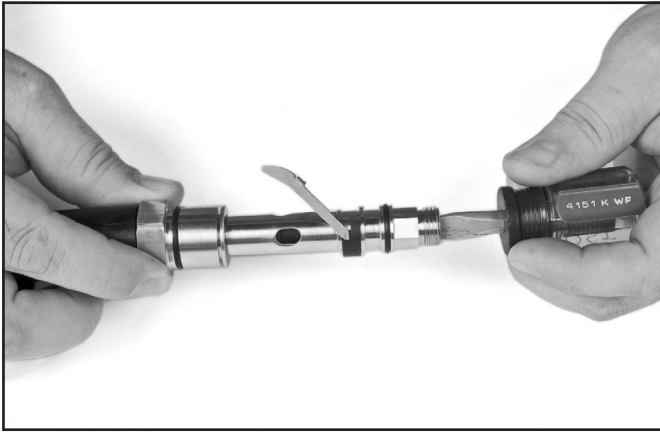

Screw the adjustment nipple into the open end of the main tube.

20) While watching for any movement of the lever, screw the adjustment nipple into the main tube. As soon as you see any movement of the lever, stop turning the nipple. Tip: This is typically very close to optimum adjustment. Turn the nipple just enough so that the lever drops $\frac{1}{8}$ inch.

21) Allow this assembly to sit for 24 hours so that the seat conforms to the adjustment nipple.



Slide the main tube and associated parts into the regulator body.

22) Carefully slide the main tube and associated parts into the regulator body.



The end of the threads on the main tube should be flush with the opening of the tube on the side of the regulator body.

23) If the main tube assembly has been properly installed in the regulator, the lever must be pointing straight up so that it will make contact with the diaphragm at the correct point. Note that the threaded end of the main tube where the bent tube adapter connects to it protrudes from the regulator body.

24) The flats on the main tube should be even with the outside end tube of the regulator body. If they are not, gently rotate the main tube assembly until the flat surfaces on the main tube align with the flat surfaces inside the tube on the regulator body.

NOTE: It is important to do steps 25, 26 and 27 in this sequence.

25) Loosen the packing nut from one to one and a half turns.



Thread the bent tube adapter onto the main tube.

26) Install the bent tube adapter and torque. See "Torque Specs" module.



Torque the packing nut. See "Torque Specs" module.

27) Re-torque the packing nut. See "Torque Specs" module.



Make sure the lock clip fully engages the packing nut.

28) Insert the lock clip into the groove on the packing nut inside the regulator body. Push down on the clip with a screwdriver until it is fully installed on the packing nut.

29) Turn the flex knob in towards the regulator body until you hear a click. This indicates the maximum distance the adjustment shaft will travel. Next, back the knob out completely until it stops.

Twist it just a but harder to make sure the packing does not come loose. Turn the knob all the way in, and then out three times.



Tighten the cover hand tight.

30) Install the diaphragm, cover and cover retaining ring. Tighten the retaining ring hand tight.

31) Install the screws and washers.

32) Test the regulator for proper adjustment. Follow the procedures in this "1.1.3 SuperFlow® 450 Demand Regulator Test for Correct Adjustment, Fully Assembled" on page SF450-1.

1.1.10 SuperFlow® 450 Regulator Installation

Tools required:

- Small Cutting Pliers
- Torque Wrench
1¹/₁₆, 7⁸/₈ inch Open End Attachments
- 3⁸/₈ inch Drive Extension—Minimum 3 Inches in Length
- 1 3⁸/₈ inch Socket or Regulator Mount Nut, P/N 525-625 (in Tool Kit included with Helmet)
- 7⁸/₈ inch Open End Wrench
- Torque Screwdriver
1⁴/₄ inch Flat Blade Attachment on Torque Screwdriver
- Christo-Lube® or equivalent oxygen compatible lubricant



Be sure to install the spacer onto the regulator tube.

2) Install the spacer onto the regulator tube and install the regulator assembly and spacer onto the helmet.

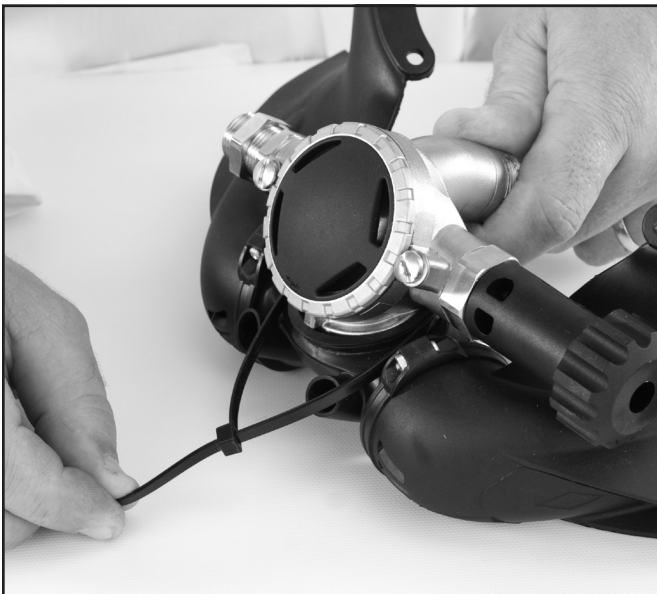

Install the tie wrap on the regulator.

1) Install the tie wrap onto the Quad Valve exhaust main body and tighten.



3) Inspect the regulator mount nut for contaminants and damage. Use a tooth brush to clean threads as needed. Lightly lubricate the regulator mounting tube threads and the sealing O-ring with Christo-Lube®.



Install the O-ring that mounts on the regulator tube inside the helmet.



Install the regulator mount nut.

4) Install the sealing O-ring, then thread the regulator mount nut onto the regulator, finger tight ONLY.



Tighten the screws that connect the quad exhaust cover to the exhaust body.

- 5) Tighten the screws that connect the quad exhaust main body to the quad exhaust cover.
- 6) Install the oral nasal mask per "1.1.3 Oral Nasal Mask Replacement" on page ON-2.
- 7) Install the nose block device per "1.2.2 Nose Block Device Replacement" on page FCPRT-6.

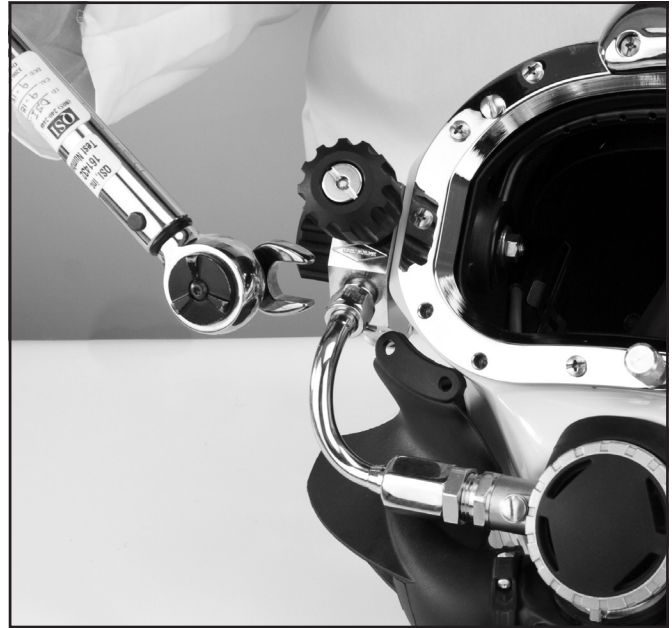

Connect the bent tube assembly and tighten at both ends.

- 8) Install the bent tube assembly, per "1.3.3 Installation of the Bent Tube Assembly" on page BNT-4.
- 9) Tighten the regulator mount nut. See "Torque Specs" module.

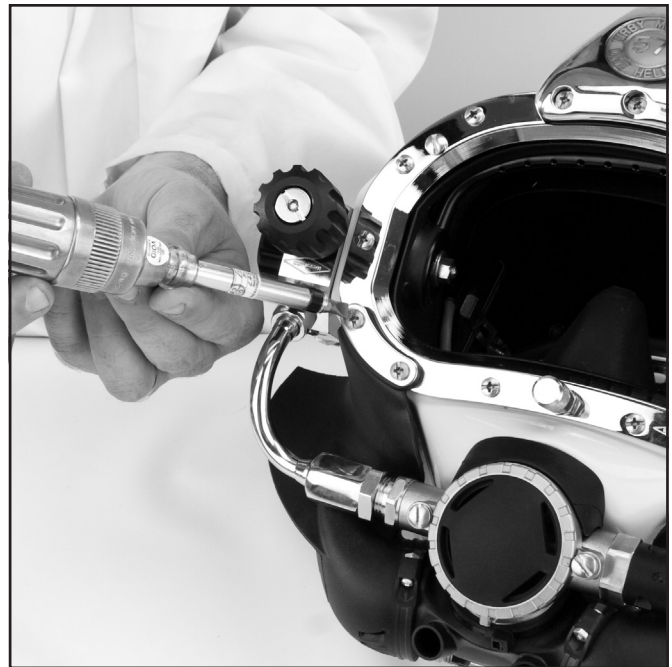

Torque the screws that fasten the whiskers to the helmet. See "Torque Specs" module.

- 10) Install the screws, kidney plates, zinc anodes

if present and whisker spacers from the whiskers.
Torque the screws. See "Torque Specs" module.